

# TEST REPORT

**Report on the submitted sample said to be:**

**Sample Name** : 2 Wheel Auto - Balancing Electric Scooter  
**Model/style** : Y1(TIRE 6.5 INCH), Y2(TIRE 6.5 INCH , Transformers shape + With Bluetooth) , Y3 (TIRE 8 INCH,With Bluetooth, Fantastic sound& LED effect), Y4 (TIRE 10 INCH)

**Sample received date** : Sep. 12, 2015  
**Testing period** : Sep. 12, 2015–Sep. 17, 2015

**TEST RESULT SUMMARY:**

TEST REQUESTED	RESULT
EN 14619:2004 Roller sports equipment – Kick scooters-Safety requirements and test methods	Pass

**REMARKS:**

1. The test report is valid for above tested sample only and shall not be reproduced in part without written approval of the company.
2. Characterization & Condition of sample: Normal.
3. Ambient Condition During Testing:(15~22)°C, (25~50) % RH.
4. N/A – Not applicable;  
F(all)-Test item does not meet the requirement  
P-Test item does meet the requirement

Prepared by:

*Calvin Chen*

Calin Chen

Examine By:

*Tony Mo*

Tony Mo

Approved(Manager):

*Michael Mo*



**TESTS CONDUCTED:**

**EN 14619:2004 Roller sports equipment – Kick scooters-Safety requirements and test methods**

1. Scope:

This document applies to kick scooters which can only be propelled by the muscular activity of a user with a body mass of more than 35 kg and less than 100 kg.

It specifies safety requirements, test methods, marking and information supplied by the manufacturer to reduce the risk of injuries to both third parties and the user during normal use.

Kick scooters for use by users of less than 35 kg do not belong to the scope of this document. They are toys.

2. Number of tested sample: 2 pieces

3. Test result: details shown as following table:

Clause	Test Item	Result
4.2	Requirements	
4.2.1	Protruding components and edges All protruding components and edges that can come into contact with body parts during normal use shall be deburred or constructed in such a way as prevent injury. Rigid and protruding parts that may cause entrapment or injuries shall be protected. This protection shall not come loose during test performed in Clause 5.	Pass
4.2.2	Parts moving against each other	
4.2.2.2	Distance between the parts The distance between accessible moveable parts shall be either smaller than 5 mm or wider than 18 mm in any position.	Pass
4.2.2.3	Folding mechanism Any folding mechanism shall be designed to fix the kick scooter for use in a simple, rigid and safe way. It shall resist all tests without damage. Fixing components should not have contact with front wheel in any position. An inadvertent unlocking of the mechanism shall be impossible. If the distance as specified in 4.2.2.2 is not met other designs to protect the user from unintentional injuries shall be provided.	N/A
4.2.2.4	Sliding mechanism Sliding mechanisms shall be protected against unintentional opening or collapse.	N/A
4.2.2.5	Springs Springs shall not be accessible if the gap between two consecutive spirals or turns allows a 5 mm diameter rod to be inserted on a 10 mm depth.	N/A
4.2.3	Steering system Avoid contact between wheels and other parts of the kick scooter. That the length adjustment fixing avoid unintentional opening. That the steering column, if it is sliding, shall be adjusted for height, and have a permanent mark that indicates the minimum insertion depth of the column; this mark shall be positioned at a distance equivalent to and not less than two and a half times the diameter of the column and shall not affect its strength. That the end of the handlebar is equipped with hand grips or plugs, which withstand a tensile load of at least 70 N.	N/A
4.2.4	Deck The deck shall resist all tests specified in Clause 5 without any functional damage. It shall be equipped with an anti-slide surface with an area of at least 200 cm <sup>2</sup> .	Pass
4.2.5	Bearings The bearings shall be designed in such a way as to be functional after performing all the tests according to Clause 5. They shall be constructed in such a way as to permit servicing according to the information supplied by the manufacturer without impairment of their operational safety.	Pass
4.2.6	Axles The axles shall be attached and designed in such a way as to ensure that they cannot become loose, displaced or deformed during use. The wheels shall be secured on the axles against unintentional loosening. These requirements are considered to be fulfilled if the axles are not loosened, deformed or displaced to such an extent as to impair proper functioning, and the wheels have not become loose after the tests according to Clause 5.	Pass

4.2.7	<p><b>Wheels</b></p> <p>The wheels shall be constructed from non-slip material. This requirement is considered to be fulfilled if a coefficient of adhesion <math>\mu</math> of at least 0.30 is achieved in the test according to 5.3.</p> <p>After the tests according to Clause 5, the wheels shall not show tearing. They shall further not have loosened or be deformed to the extent that a risk of their becoming locked exists.</p>	Pass
4.2.8	<p><b>Self-locking fixings</b></p> <p>Where self-locking nuts are used, the entire thread, including the locking section, shall be in contact with the bolt. Self-locking nuts and other self-locking fixings that are loosened several times for the purpose of modification or servicing shall be suitable for this purpose. The information supplied by the manufacturer shall indicate when self-locking nuts and other self-locking elements can lose their effectiveness.</p>	N/A
4.2.9	<p><b>Mechanism to reduce the speed</b></p> <p>If a kick scooter is equipped with a mechanism to reduce the speed this mechanism shall continue to make contact with the surface to which it is intended and no fastening devices shall have loosened when tested according to Clause 5.</p> <p>The mechanism shall effectively and smoothly reduce the speed without coming to an abrupt stop.</p>	N/A
4.2.10	<p><b>Strength</b></p> <p>All functional parts after testing according to Clause 5 shall not collapse or fail to comply with the relevant requirements specified in this document.</p>	Pass
<b>5</b>	<b>Test Method</b>	
5.1	General	Pass
5.3	Wheel adhesion test	Pass
	The wheel adhesion shall be tested by pulling a wheel along a steel plate with a fine brushed and degreased surface of arithmetical mean roughness Ra of 1,5 to 2.0 $\mu$ m	Pass
5.4	Static load test	Pass
	Deck: A test load of 200kg with a surface of 100mmX100mm applied on the center of the deck Steering column The steering column shall be extended to the maximum and centrally loaded with a 50Kg mass applied in directions A and B, each for 5min	Pass
5.7	<p><b>Endurance test</b></p> <p>A Complete kick scooter shall with stand the edurance test. This test is carried out on a test apparatus as shown in Figure 5 and at circumferential speed of 0,5m/s for a dsitance fo 12km. A mass of 90 kg shall placed centrally on the deck. 10kg shall be placed out of the handlebar of joy stick .</p>	Pass
<b>6</b>	<b>Marking</b>	
6.1	<p><b>On the kick scooter</b></p> <p>Each kick scooter shall be legibly and durably marked with the specified information.</p>	N/A
6.2	<p><b>On the package</b></p> <p>The specified information shall be provided on the package:</p>	Pass
<b>7</b>	<b>Information supplied by the manufacturer</b>	
7.1	<p><b>General</b></p> <p>All kick scooters shall be supplied with information supplied by the manufacturer. This documents shall contain, in text or picture form, at least the information in accordance with 7.2 and 7.3 as well as the information given in Clause 7 including the address according 7.1 a).</p>	Pass
7.2	<p><b>Instructions for use</b></p> <p>The specified information shall be included.</p>	Pass
7.3	<p><b>Servicing and maintenance instructions</b></p> <p>Clear advice stating that regular maintenance enhances the safety of the kick scooter.</p>	Pass

ATTACHMENT : REAL PHOTOS OF EUT



Photo 1



Photo 2



Photo 3

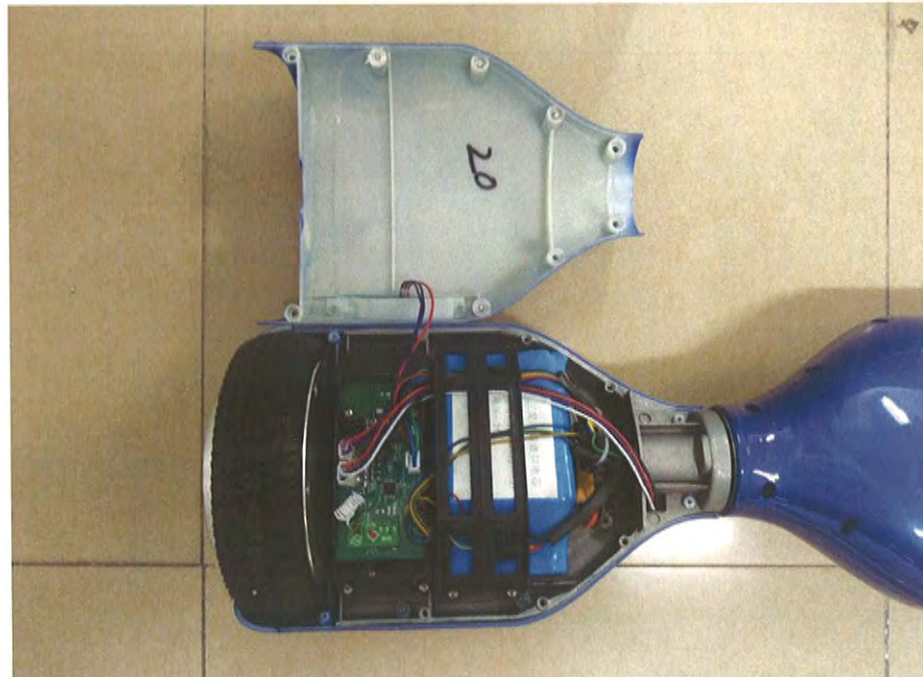

Photo 4



Photo 5

\*\*\* THE END OF REPORT \*\*\*



# FCC TEST REPORT

FCC Part 15B: 2013

## MEASUREMENT AND TEST REPORT

For

**Model:** Y1 (TIRE 6.5 INCH), Y4 (TIRE 10 INCH), Y2 (TIRE 6.5 INCH, Transformers shape + With Bluetooth), Y3 (TIRE 8 INCH, With Bluetooth, Fantastic sound & LED effect)

Apr. 14, 2014

<b>This Report Concerns:</b> <input checked="" type="checkbox"/> Original Report	<b>Equipment Type:</b> 2 Wheel Auto - Balancing Electric Scooter
<b>Test Engineer:</b>	<i>Bill Jiang</i>
<b>Report Number:</b>	POCE14041033KRR
<b>Test Date:</b>	Apr. 07, 2014 to Apr. 14, 2014
<b>Reviewed By:</b>	<i>Michael</i>
<b>Prepared By:</b>	<b>Shenzhen POCE Technology Co., Ltd.</b> H Building, Hongfa Science and Technology Park, Tangtou, Shiyao, Bao'an District, Shenzhen, China Tel: 86-755-2911 3252 Fax: 86-755-2911 3135

**Note:** This test report is limited to the above client company and the product model only. It may not be duplicated without prior written consent of Shenzhen POCE Technology Co., Ltd.

## TABLE OF CONTENTS

Description	Page
The Report Description	
<b>1 GENERAL INFORMATION .....</b>	<b>3</b>
1.1. Description of Device (EUT).....	3
1.2. Description of test facility .....	4
1.3. Test Standards.....	4
1.4. Test Summary .....	4
1.5. Measurement Uncertainty.....	4
<b>2. POWER LINE CONDUCTED MEASUREMENT .....</b>	<b>5</b>
2.1. Test Equipment .....	5
2.2. Block Diagram of Test Setup.....	5
2.3. Power Line Conducted Emission Measurement Limits (Class B) .....	5
2.4. Configuration of EUT on Measurement .....	6
2.5. Operating Condition of EUT .....	6
2.6. Test Procedure .....	6
2.7. Power Line Conducted Emission Measurement Results .....	6
<b>3. RADIATED EMISSION MEASUREMENT .....</b>	<b>9</b>
3.1. Test Equipment .....	9
3.2. Block Diagram of Test Setup.....	9
3.3. Radiated Emission Limit (Class B) .....	9
3.4. EUT Configuration on Measurement .....	9
3.5. Operating Condition of EUT .....	9
3.6. Test Procedure .....	9
3.7. Radiated Emission Measurement Results.....	9
 APPENDIX I (Photos of EUT)	



# 1 GENERAL INFORMATION

## 1.1. Description of Device (EUT)

EUT : 2 Wheel Auto - Balancing Electric Scooter

Trade Name: : N/A

Model Number : Y1 (TIRE 6.5 INCH)

Supplementary Model : Y4 (TIRE 10 INCH), Y2 (TIRE 6.5 INCH, Transformers shape + With Bluetooth), Y3 (TIRE 8 INCH, With Bluetooth, Fantastic sound & LED effect) Remark: supplementary models are only different in exterior with tested Model and with the same circuit construction. All the tests of this report are carried on Model Y1 (TIRE 6.5 INCH)

Test Voltage : 120V, 60Hz

Received : Apr. 07, 2014

Date of Test : Apr. 07, 2014 to Apr. 14, 2014

## 1.2. Description of test facility

All measurement required was performed at laboratory of Shenzhen POCE Technology Co., Ltd. at H Building, Hongfa Science and Technology Park, Tangtou, Shiyan, Bao'an District, Shenzhen, China

The test facility is recognized, certified, or accredited by the following organizations:

FCC – Registration No.: 222278

Shenzhen POCE Technology Co., Ltd. EMC Laboratory has been registered and fully described in a report filed with the (FCC) Federal Communications Commission. The acceptance letter from the FCC is maintained in our files. Registration 222278, June 08, 2010.

## 1.3. Test Standards

The following Declaration of Conformity report of EUT is prepared in accordance with

47CFR Part 15(2012): Radio Frequency Device: Subpart B; Unintentional radiators Class B

ANSI C63.4 (2009): Interim Standard for Methods of Measurement of Radio-Noise Emissions from Low-Voltage Electrical and Electronic Equipment in the Range of 9KHz to 40GHz.

## 1.4. Test Summary

TEST ITEMS	RESULT	NOTE
Disturbance voltage at a.c. mains terminal	PASS	
Radiated emission	PASS	

Notes: N/A=Not Applicable

## 1.5. Measurement Uncertainty

Radiation Uncertainty :  $U_r = \pm 3.84\text{dB}$

Conduction Uncertainty :  $U_c = \pm 2.72\text{dB}$

## 2. POWER LINE CONDUCTED MEASUREMENT

### 2.1. Test Equipment

The following test equipments are used during the conducted emission measurement:

Item	Test Equipment	Manufacturer	Model No.	Inventory No.	Cal.Date (mm-dd-yy)	Cal.Due date (mm-dd-yy)
1	Shielding Room	ZhongYu Electron	7.3(L)x3.1(W)x2.9(H)	GTS252	Sep. 07 2014	Sep. 06 2015
2	EMI Test Receiver	R&S	ESCS30	GTS223	Jun. 29 2014	Jun. 29 2015
3	Pulse Limiter	R&S	ESH3-Z2	GTS224	Jun. 29 2014	Jun. 29 2015
4	Coaxial Switch	ANRITSU CORP	MP59B	GTS225	Jun. 29 2014	Jun. 29 2015
5	Artificial Mains Network	SCHWARZBECK MESS	NSLK8127	GTS226	Jun. 29 2014	Jun. 29 2015
6	Coaxial Cable	GTS	N/A	GTS227	Jul. 07 2014	Jul. 06 2015
7	EMI Test Software	AUDIX	E3	N/A	N/A	N/A
8	Thermo meter	KTJ	TA328	GTS233	Jul. 01 2014	Jul. 01 2015

### 2.2. Block Diagram of Test Setup

#### 2.2.1 Block diagram of connection between the EUT and simulators



(EUT: 2 Wheel Auto - Balancing Electric Scooter)

#### 2.2.2 Block diagram of test setup

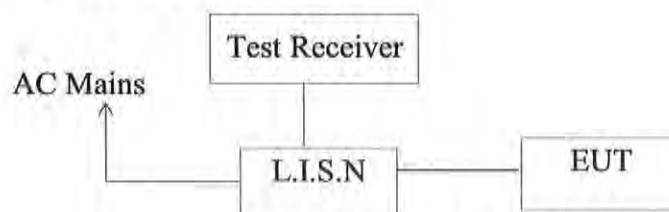

(EUT: 2 Wheel Auto - Balancing Electric Scooter)

### 2.3. Power Line Conducted Emission Measurement Limits (Class B)

Frequency MHz	Limits dB(μV)	
	Quasi-peak Level	Average Level
0.15 ~ 0.50	66 ~ 56*	56 ~ 46*
0.50 ~ 5.00	56	46
5.00 ~ 30.00	60	50

Notes: 1. \*Decreasing linearly with logarithm of frequency.

2. The lower limit shall apply at the transition frequencies.

## 2.4. Configuration of EUT on Measurement

The following equipments are installed on Power Line Conducted Emission Measurement to meet the commission requirement and operating regulations in a manner, which tends to maximize its emission characteristics in a normal application.

EUT : 2 Wheel Auto - Balancing Electric Scooter  
Model Number : Y1 (TIRE 6.5 INCH)

## 2.5. Operating Condition of EUT

- 2.5.1. Setup the EUT and simulator as shown as Section 2.2.
- 2.5.2. Turn on the power of all equipment.
- 2.5.3. Let the EUT work in test mode (Normal) and measure it.

## 2.6. Test Procedure

The EUT system is connected to the power mains through a line impedance stabilization network (L.I.S.N.). This provides 50ohm-coupling impedance for the EUT system. Please refer the block diagram of the test setup and photographs. Both sides of AC line are checked to find out the maximum conducted emission. In order to find the maximum emission levels, the relative positions of equipment and all of the interface cables shall be changed according to FCC/ANSI C63.4-2009 on Conducted Emission Measurement.

The bandwidth of test receiver (R & S ESCS30) is set at 9KHz.

The frequency range from 150KHz to 30MHz is checked.

The test result is reported on Section 2.7.

The frequency range from 150KHz to 30 MHz is investigated.

## 2.7. Power Line Conducted Emission Measurement Results

**PASS**

Please reference to the following pages

## Conducted Disturbance Test Data

EUT: 2 Wheel Auto - Balancing Electric Scooter  
 M/N: Y1 (TIRE 6.5 INCH)  
 Operating Condition: Normal Working  
 Test Site: 3m Shielded  
 Operator: Bill  
 Test Specification: L 120V/60Hz

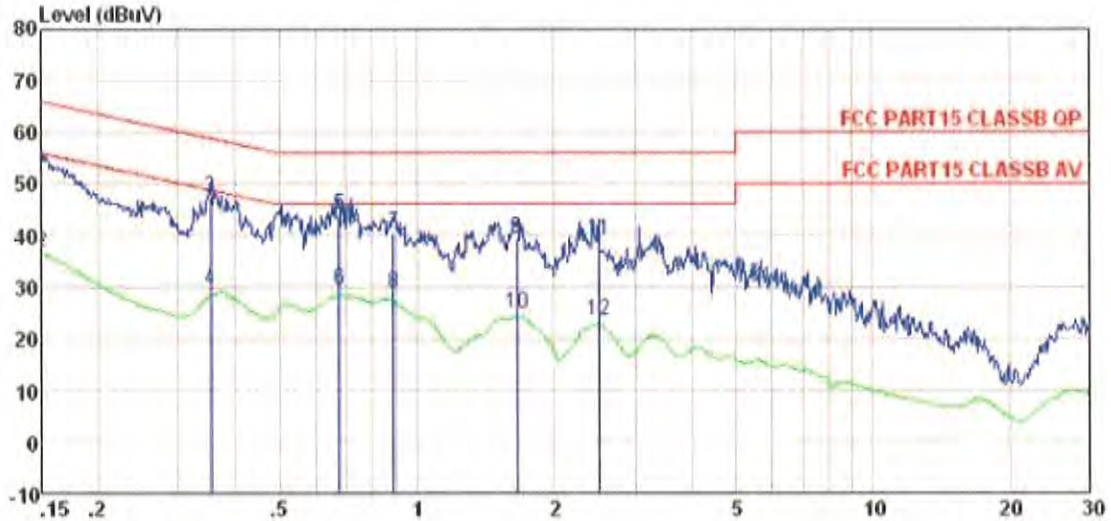

	Freq	Read Level	LISN Factor	Cable Loss	Level	Limit Line	Over Limit	Remark
	MHz	dBuV	dB	dB	dBuV	dBuV	dB	
1	0.150	52.38	0.15	0.12	52.65	66.00	-13.35	QP
2	0.150	36.40	0.15	0.12	36.67	56.00	-19.33	Average
3	0.352	47.19	0.11	0.10	47.40	58.91	-11.51	QP
4	0.352	29.41	0.11	0.10	29.62	48.91	-19.29	Average
5	0.675	43.83	0.14	0.13	44.10	56.00	-11.90	QP
6	0.675	29.10	0.14	0.13	29.37	46.00	-16.63	Average
7	0.885	40.29	0.14	0.13	40.56	56.00	-15.44	QP
8	0.885	28.56	0.14	0.13	28.83	46.00	-17.17	Average
9	1.654	39.39	0.12	0.14	39.65	56.00	-16.35	QP
10	1.654	24.65	0.12	0.14	24.91	46.00	-21.09	Average
11	2.500	38.96	0.13	0.15	39.24	56.00	-16.76	QP
12	2.500	23.24	0.13	0.15	23.52	46.00	-22.48	Average

**Conducted Disturbance Test Data**

EUT: 2 Wheel Auto - Balancing Electric Scooter

M/N: Y1 (TIRE 6.5 INCH)  
 Operating Condition: Normal Working  
 Test Site: 3m Shielded  
 Operator: Bill  
 Test Specification: N 120V/60Hz

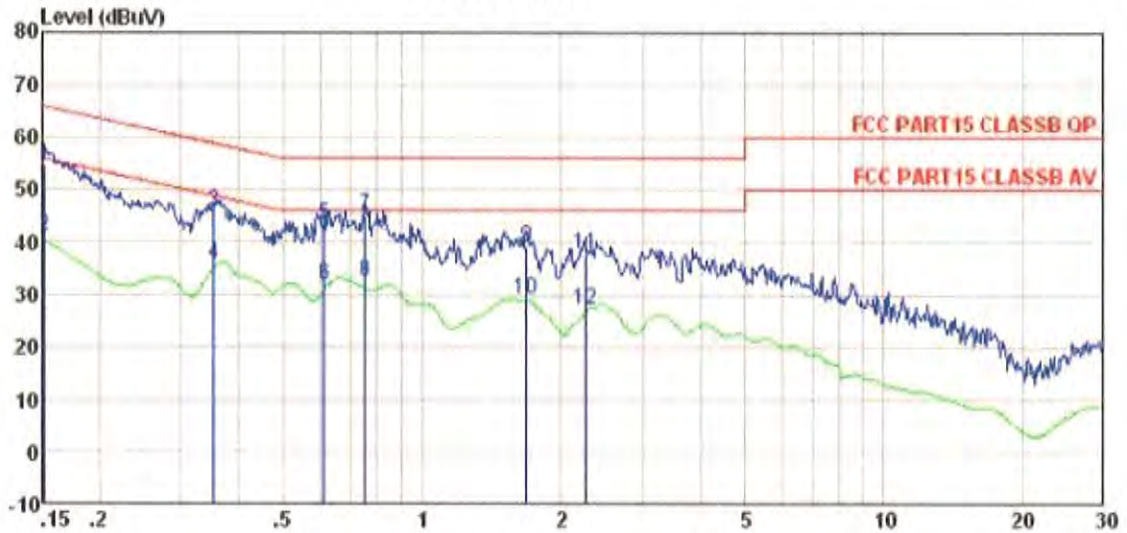

	Freq	Read Level	LISN Factor	Cable Loss	Level	Limit Line	Over Limit	Remark
	MHz	dBuV	dB	dB	dBuV	dBuV	dB	
1	0.152	54.60	0.07	0.12	54.79	65.91	-11.12	QP
2	0.152	40.79	0.07	0.12	40.98	55.91	-14.93	Average
3	0.354	45.66	0.06	0.10	45.82	58.87	-13.05	QP
4	0.354	35.83	0.06	0.10	35.99	48.87	-12.88	Average
5	0.614	43.30	0.07	0.12	43.49	56.00	-12.51	QP
6	0.614	31.49	0.07	0.12	31.68	46.00	-14.32	Average
7	0.751	45.00	0.07	0.13	45.20	56.00	-10.80	QP
8	0.751	32.20	0.07	0.13	32.40	46.00	-13.60	Average
9	1.680	38.83	0.09	0.14	39.06	56.00	-16.94	QP
10	1.680	29.06	0.09	0.14	29.29	46.00	-16.71	Average
11	2.249	37.64	0.09	0.15	37.88	56.00	-18.12	QP
12	2.249	26.88	0.09	0.15	27.12	46.00	-18.88	Average

### 3. RADIATED EMISSION MEASUREMENT

#### 3.1. Test Equipment

The following test equipments are used during the radiated emission measurement:

##### 3.1.1. For Anechoic Chamber

Item	Test Equipment	Manufacturer	Model No.	Inventory No.	Cal.Date (mm-dd-yy)	Cal.Due date (mm-dd-yy)
1	3m Semi- Anechoic Chamber	ZhongYu Electron	9.0(L)*6.0(W)* 6.0(H)	GTS250	Mar. 28 2014	Mar. 27 2015
2	Control Room	ZhongYu Electron	6.2(L)*2.5(W)* 2.4(H)	GTS251	N/A	N/A
3	ESU EMI Test Receiver	R&S	ESU26	GTS203	Jun. 29 2014	Jun. 29 2015
4	BiConiLog Antenna	SCHWARZBECK	VULB9163	GTS214	Jun. 29 2014	Jun. 29 2015
5	Double -ridged waveguide horn	SCHWARZBECK	9120D	GTS208	Jun. 29 2014	Jun. 29 2015
6	RF Amplifier	HP	8347A	GTS204	Jun. 29 2014	Jun. 29 2015
7	Preamplifier	HP	8349B	GTS206	Jun. 29 2014	Jun. 29 2015
8	EMI Test Software	AUDIX	E3	N/A	N/A	N/A
9	Coaxial cable	GTS	N/A	GTS210	Jul. 07 2014	Jul. 06 2015
10	Coaxial Cable	GTS	N/A	GTS211	Jul. 07 2014	Jul. 06 2015
11	Thermo meter	N/A	N/A	GTS256	Jul. 01 2014	Jul. 01 2015

## 3.2. Block Diagram of Test Setup

### 3.2.1. Block diagram of connection between the EUT and simulators



(EUT: 2 Wheel Auto - Balancing Electric Scooter)

### 3.2.2. Anechoic Chamber Test Setup Diagram

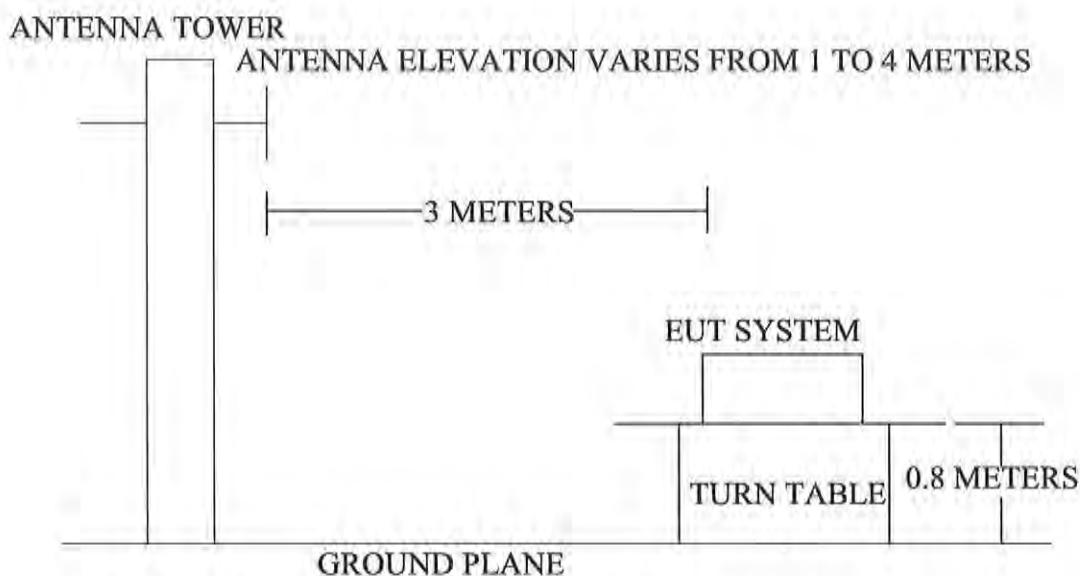

(EUT: 2 Wheel Auto - Balancing Electric Scooter)

## 3.3. Radiated Emission Limit (Class B)

FREQUENCY MHz	DISTANCE Meters	FIELD STRENGTHS LIMIT	
		$\mu\text{V}/\text{m}$	$\text{dB}(\mu\text{V})/\text{m}$
30 ~ 88	3	100	40.0
88 ~ 216	3	150	43.5
216 ~ 960	3	200	46.0
960 ~ 1000	3	500	54.0

Remark: (1) Emission level  $(\text{dB})\mu\text{V} = 20 \log$  Emission level  $\mu\text{V}/\text{m}$   
 (2) The smaller limit shall apply at the cross point between two frequency bands.  
 (3) Distance is the distance in meters between the measuring instrument, antenna and the closest point of any part of the device or system.

## 3.4. EUT Configuration on Measurement

The following equipment are installed on Radiated Emission Measurement to meet the



commission requirements and operating regulations in a manner which tends to maximize its emission characteristics in normal application.

#### 2 Wheel Auto - Balancing Electric Scooter (EUT)

Model Number : Y1 (TIRE 6.5 INCH)  
Serial Number : N/A

### 3.5. Operating Condition of EUT

1. Setup the EUT as shown in Section 3.2.
2. Let the EUT work in test mode (Normal) and measure it.

### 3.6. Test Procedure

EUT and its simulators are placed on a turntable, which is 0.8 meter high above ground. The turntable can rotate 360 degrees to determine the position of the maximum emission level. EUT is set 3.0 meters away from the receiving antenna, which is mounted on an antenna tower. The antenna can be moved up and down between 1.0 meter and 4 meters to find out the maximum emission level. Broadband antenna (calibrated bilog antenna) is used as receiving antenna. Both horizontal and vertical polarization of the antenna is set on measurement. In order to find the maximum emission levels, all of the interface cables must be manipulated according to ANSI C63.4-2009 on radiated emission measurement.

The bandwidth of the EMI test receiver (R&S ESCS30) is set at 120KHz.

The frequency range from 30MHz to 1000MHz is investigated.

### 3.7. Radiated Emission Measurement Results

**PASS**

Please reference to the following pages

**Radiated Emission Test Data**

EUT: 2 Wheel Auto - Balancing Electric Scooter  
 M/N: Y1 (TIRE 6.5 INCH)  
 Operating Condition: Normal  
 Test Site: 3m CHAMBER  
 Operator: Bill  
 Test Specification: 120V, 60Hz  
 Comment: Polarization: Vertical  
 Note: Charging Mode

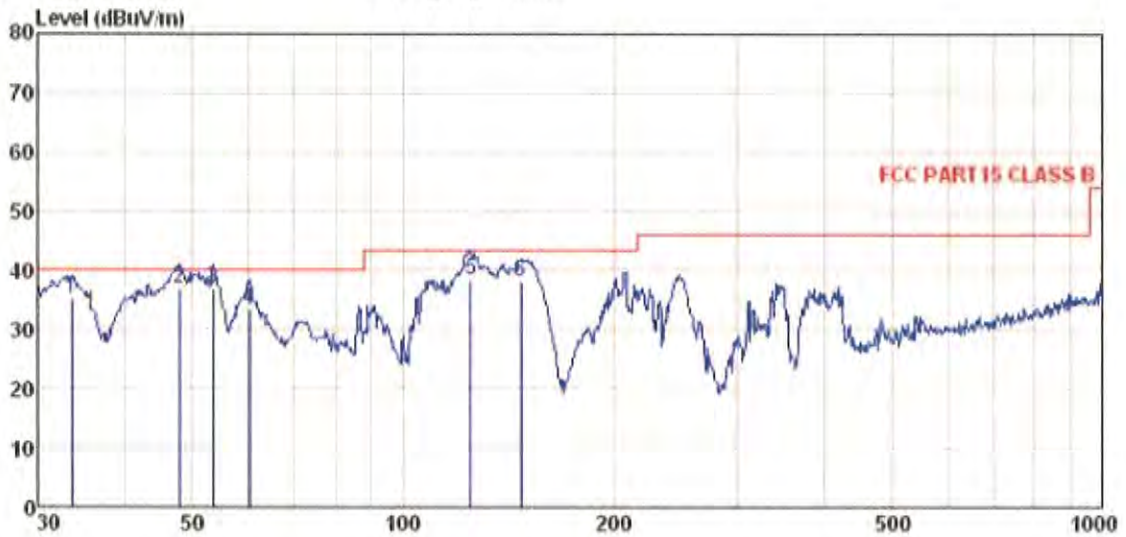

	Freq	ReadAntenna	Cable	Preamp	Level	Limit	Over	
	MHz	Level	Factor	Loss	Factor	Line	Limit	Remark
		dBuV	dB/m	dB	dB	dBuV/m	dBuV/m	dB
1	33.680	52.14	14.31	0.59	32.06	34.98	40.00	-5.02 QP
2	47.826	52.78	15.38	0.75	31.98	36.93	40.00	-3.07 QP
3	53.505	52.99	15.08	0.80	31.95	36.92	40.00	-3.08 QP
4	60.280	49.73	14.69	0.86	31.94	33.34	40.00	-6.66 QP
5	124.569	57.00	11.80	1.40	31.88	38.32	43.50	-5.18 QP
6	146.888	58.15	10.24	1.55	31.97	37.97	43.50	-5.53 QP

**Radiated Emission Test Data**

EUT: 2 Wheel Auto - Balancing Electric Scooter  
 M/N: Y1 (TIRE 6.5 INCH)  
 Operating Condition: Normal  
 Test Site: 3m CHAMBER  
 Operator: Bill  
 Test Specification: 120V, 60Hz  
 Comment: Polarization: Horizontal  
 Note: Charging Mode

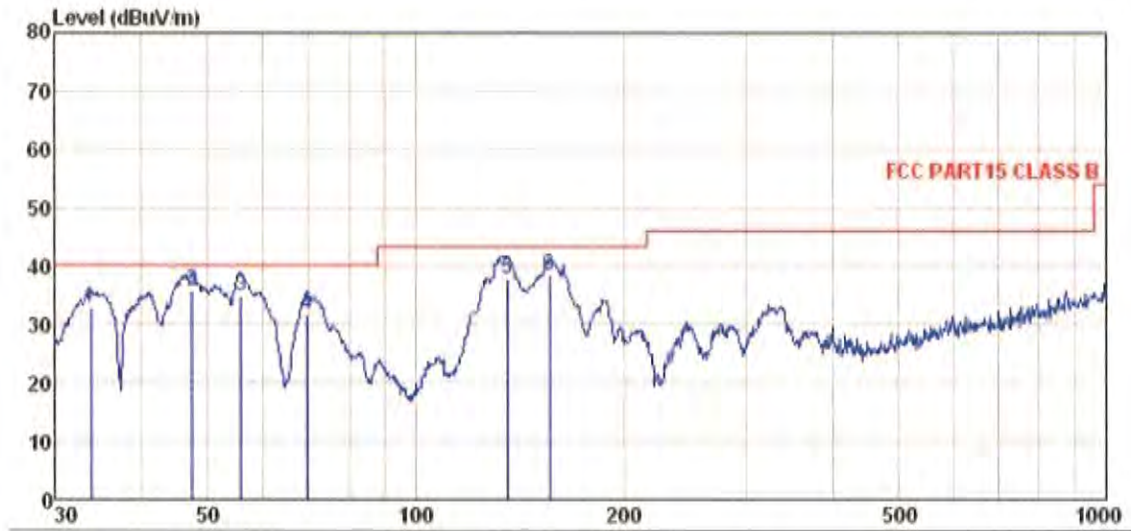

	ReadAntenna	Cable Preamp	Limit	Over	Remark			
Freq	Level	Factor	Loss	Factor	Level	Line	Limit	Remark
MHz	dBuV	dB/m	dB	dB	dBuV/m	dBuV/m	dB	
1	33.799	49.80	14.31	0.59	32.06	32.64	40.00	-7.36 QP
2	47.492	51.54	15.41	0.74	31.98	35.71	40.00	-4.29 QP
3	55.805	51.10	14.97	0.82	31.95	34.94	40.00	-5.06 QP
4	69.600	51.75	10.79	0.94	31.88	31.60	40.00	-8.40 QP
5	135.506	57.66	10.51	1.47	31.93	37.71	43.50	-5.79 QP
6	155.910	58.19	10.51	1.60	32.00	38.30	43.50	-5.20 QP

**Radiated Emission Test Data**

EUT: 2 Wheel Auto - Balancing Electric Scooter  
 M/N: Y1 (TIRE 6.5 INCH)  
 Operating Condition: Normal  
 Test Site: 3m CHAMBER  
 Operator: Bill  
 Test Specification: 120V, 60Hz  
 Comment: Polarization: Vertical  
 Note: On Mode

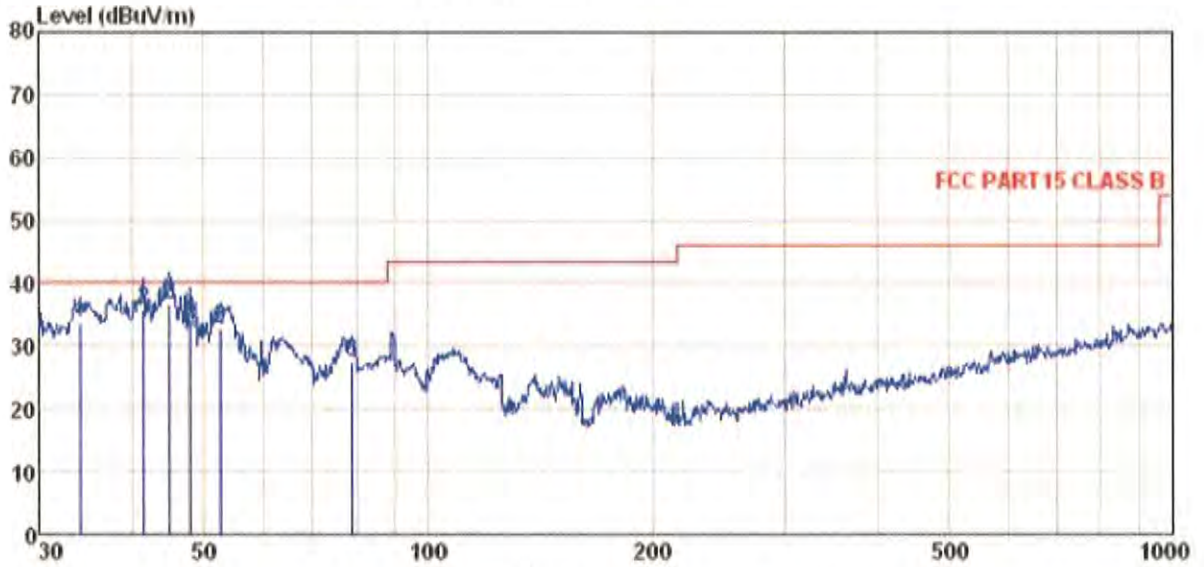

	Freq	ReadAntenna	Cable Preamp	Limit	Over	Remark			
	MHz	Level	Factor	Loss	Factor	Level	Line	Limit	
		dBuV	dB/m	dB	dB	dBuV/m	dBuV/m	dB	
1	34.156	50.84	14.31	0.60	32.06	33.69	40.00	-6.31	QP
2	41.567	51.47	15.57	0.68	32.04	35.68	40.00	-4.32	QP
3	45.058	52.25	15.55	0.72	32.01	36.51	40.00	-3.49	QP
4	47.994	50.13	15.36	0.75	31.98	34.26	40.00	-5.74	QP
5	52.575	48.89	15.14	0.79	31.95	32.87	40.00	-7.13	QP
6	78.965	47.85	10.43	1.02	31.77	27.53	40.00	-12.47	QP

**Radiated Emission Test Data**

EUT: 2 Wheel Auto - Balancing Electric Scooter

M/N: Y1 (TIRE 6.5 INCH)  
 Operating Condition: Normal  
 Test Site: 3m CHAMBER  
 Operator: Bill  
 Test Specification: 120V, 60Hz  
 Comment: Polarization: Horizontal  
 Note: On Mode

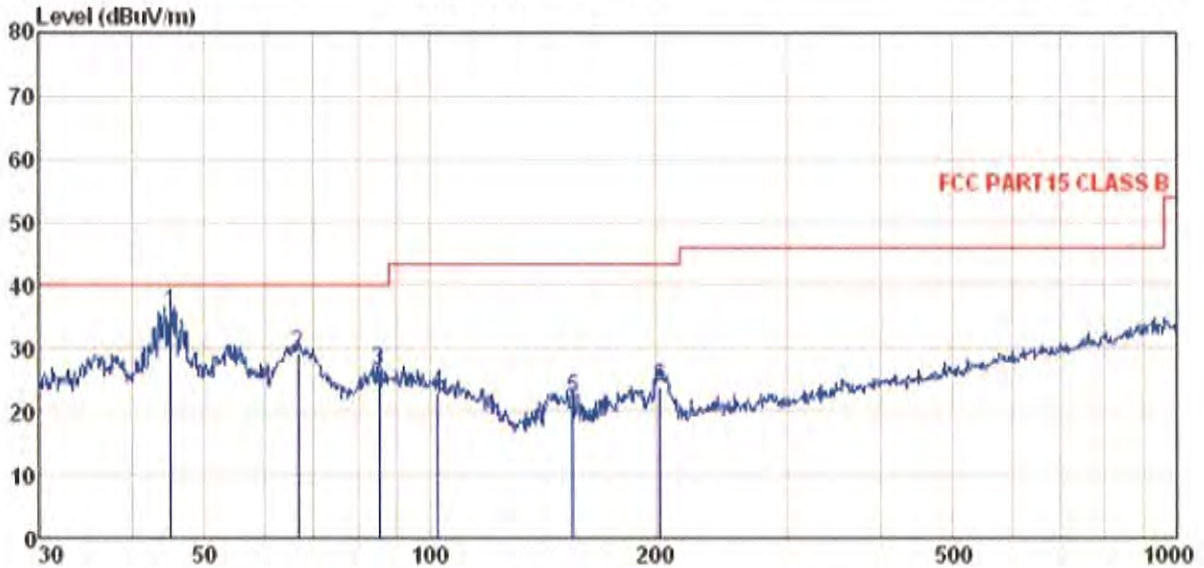

	Read Freq	Antenna Level	Antenna Factor	Cable Loss	Preamp Factor	Level	Limit	Over	Remark
	MHz	dBuV	dB/m	dB	dB	dBuV/m	dBuV/m	dB	
1	45.058	51.39	15.55	0.72	32.01	35.65	40.00	-4.35	QP
2	66.499	48.22	12.02	0.91	31.90	29.25	40.00	-10.75	QP
3	85.298	44.70	12.45	1.07	31.74	26.48	40.00	-13.52	QP
4	102.360	38.78	14.92	1.21	31.77	23.14	43.50	-20.36	QP
5	155.364	41.97	10.48	1.60	32.00	22.05	43.50	-21.45	QP
6	202.810	41.44	12.64	1.86	32.14	23.80	43.50	-19.70	QP

# APPENDIX I

## (Photos of EUT)

**FIGURE**  
GENERAL APPEARANCE OF EUT



Fig. 1



Fig. 2

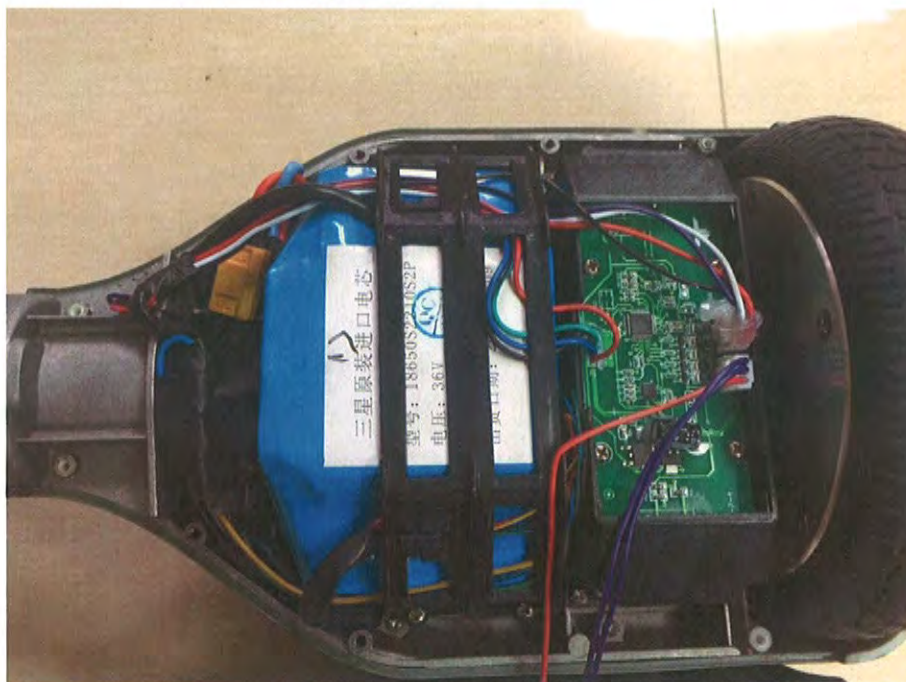

Fig. 3

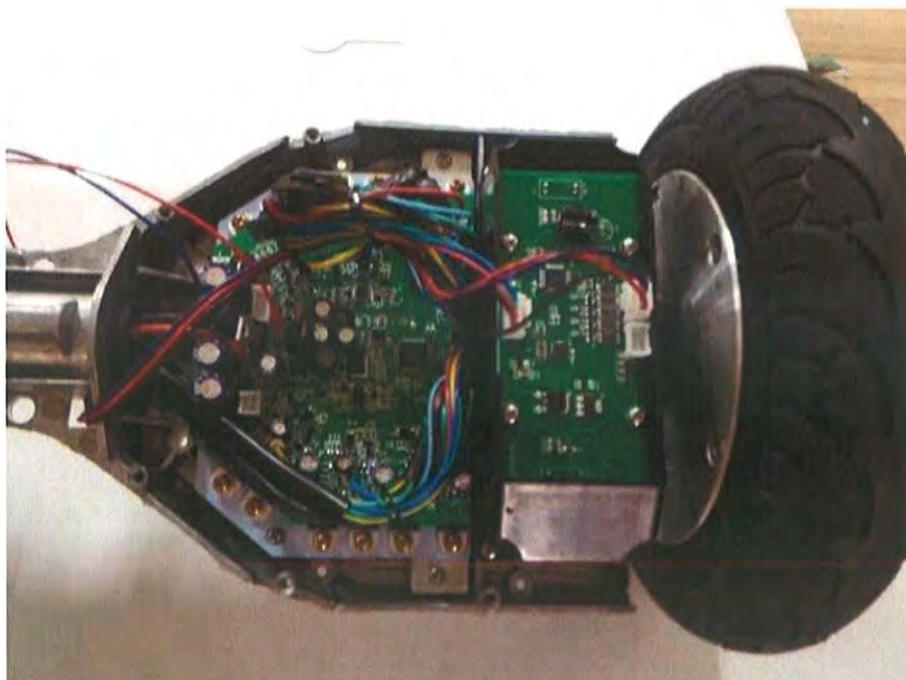

Fig. 4

\*\*\*\*\*THE END\*\*\*\*\*





# EMC TEST REPORT

EN55014-1:2006+A1:2009+ A2:2011  
EN55014-2:1997+A1:2001+A2:2008  
EN61000-3-2:2006+A1:2009+A2:2009  
EN 61000-3-3:2013

## MEASUREMENT AND TEST REPORT For

**Model:** Y1 (TIRE 6.5 INCH), Y4 (TIRE 10 INCH), Y2 (TIRE 6.5 INCH,  
Transformers shape + With Bluetooth), Y3 (TIRE 8 INCH,  
With Bluetooth, Fantastic sound & LED effect)

Apr. 14, 2014

<b>This Report Concerns:</b> <input checked="" type="checkbox"/> Original Report	<b>Equipment Type:</b> 2 Wheel Auto - Balancing Electric Scooter
<b>Test Engineer:</b>	<i>Bill Jiang</i>
<b>Report Number:</b>	POCE14041019MRE
<b>Test Date:</b>	Apr. 07, 2014 to Apr. 14, 2014
<b>Reviewed By:</b>	<i>Michael Wu</i>
<b>Prepared By:</b>	<b>Shenzhen POCE Technology Co., Ltd.</b> H Building, Hongfa Science and Technology Park, Tangtou, Shiyan, Bao'an District, Shenzhen, China Tel: 86-755-29113252 Fax: 86-755-29113135

Note: This test report is limited to the above client company and the product model only. It may not be duplicated without prior written consent of Shenzhen POCE Technology Co., Ltd.

**TABLE OF CONTENTS**

<b>1. GENERAL INFORMATION .....</b>	<b>4</b>
1.1 PRODUCT DESCRIPTION FOR EQUIPMENT UNDER TEST (EUT) .....	4
1.2 TEST STANDARDS .....	4
1.3 TEST SUMMARY .....	5
1.4 TEST METHODOLOGY .....	5
1.5 TEST FACILITY .....	6
1.6 TEST EQUIPMENT LIST AND DETAILS .....	6
<b>2. SYSTEM TEST CONFIGURATION.....</b>	<b>8</b>
2.1 JUSTIFICATION .....	8
2.2 EUT EXERCISE SOFTWARE.....	8
2.3 SPECIAL ACCESSORIES.....	8
2.4 EQUIPMENT MODIFICATIONS.....	8
2.5 CONFIGURATION OF TEST SYSTEM.....	8
2.6 TEST SETUP DIAGRAM.....	8
<b>3. DISTURBANCE VOLTAGE AT THE MAINS TERMINALS.....</b>	<b>9</b>
3.1 MEASUREMENT UNCERTAINTY .....	9
3.2 LIMIT OF DISTURBANCE VOLTAGE AT THE MAINS TERMINALS .....	9
3.3 EUT SETUP.....	9
3.4 INSTRUMENTS SETUP.....	10
3.5 TEST PROCEDURE.....	10
3.6 SUMMARY OF TEST RESULTS .....	10
3.7 DISTURBANCE VOLTAGE TEST DATA .....	10
3.8 TEST RESULT .....	10
<b>4. DISCONTINUOUS DISTURBANCE (CLICK) .....</b>	<b>13</b>
4.1 LIMIT OF DISCONTINUOUS DISTURBANCE .....	13
4.2 EUT SETUP.....	13
4.3 TEST PROCEDURE.....	13
4.4 SUMMARY OF TEST RESULTS .....	13
4.5 DISTURBANCE VOLTAGE TEST DATA .....	13
4.6 TEST RESULT .....	13
<b>5. DISTURBANCE POWER .....</b>	<b>14</b>
5.1 MEASUREMENT UNCERTAINTY .....	14
5.2 LIMIT OF DISTURBANCE POWER .....	14
5.3 EUT SETUP.....	14
5.4 INSTRUMENTS SETUP.....	15
5.5 TEST PROCEDURE.....	15
5.6 DISTURBANCE POWER TEST DATA.....	15
5.7 TEST PLOT(S) FOR DISTURBANCE POWER .....	15
5.8 TEST RESULT .....	15
<b>6. RADIATED EMISSION MEASUREMENT.....</b>	<b>18</b>
6.1 BLOCK DIAGRAM OF TEST .....	18
6.2 MEASURING STANDARD .....	18
6.3 RADIATED EMISSION LIMITS.....	19
6.4 EUT CONFIGURATION ON TEST .....	19
6.5 OPERATING CONDITION OF EUT .....	19
6.6 TEST PROCEDURE.....	19
6.7 MEASURING RESULTS.....	19
<b>7. HARMONIC CURRENT TEST (EN 61000-3-2) .....</b>	<b>22</b>
7.1 APPLICATION OF HARMONIC CURRENT EMISSION.....	22
7.2 MEASUREMENT DATA .....	22
7.3 TEST RESULTS.....	22
<b>8. VOLTAGE FLUCTUATIONS AND FLICKER TEST (EN 61000-3-3).....</b>	<b>28</b>
8.1 APPLICATION OF VOLTAGE FLUCTUATIONS AND FLICKER TEST.....	28
8.2 MEASUREMENT DATA .....	28
8.3 TEST RESULTS.....	28

<b>9. ELECTROSTATIC DISCHARGE IMMUNITY TEST (EN 61000-4-2)</b> .....	<b>29</b>
9.1 BLOCK DIAGRAM OF TEST SETUP.....	29
9.2 TEST STANDARD .....	29
9.3 SEVERITY LEVELS AND PERFORMANCE CRITERION .....	29
9.4 OPERATING CONDITION OF EUT .....	29
9.5 TEST PROCEDURE.....	30
9.6 TEST RESULTS.....	30
<b>10.0 RF FIELD STRENGTH SUSCEPTIBILITY TEST</b> .....	<b>32</b>
10.1 BLOCK DIAGRAM OF TEST .....	32
10.2 TEST STANDARD .....	32
10.3 SEVERITY LEVELS AND PERFORMANCE CRITERION .....	33
10.4 EUT CONFIGURATION ON TEST.....	33
10.5 OPERATING CONDITION OF EUT .....	33
10.6 TEST PROCEDURE.....	33
10.7 TEST RESULTS.....	33
<b>11. ELECTRICAL FAST TRANSIENT/BURST IMMUNITY TEST (EN 61000-4-4)</b> .....	<b>35</b>
11.1 BLOCK DIAGRAM OF TEST SETUP.....	35
11.2 TEST STANDARD .....	35
11.3 SEVERITY LEVELS AND PERFORMANCE CRITERION .....	35
11.4 OPERATING CONDITION OF EUT .....	35
11.5 TEST PROCEDURE .....	36
11.6 TEST RESULT .....	36
<b>12. SURGE IMMUNITY TEST (EN 61000-4-5)</b> .....	<b>37</b>
12.1 BLOCK DIAGRAM OF TEST SETUP.....	37
12.2 TEST STANDARD .....	37
12.3 SEVERITY LEVELS AND PERFORMANCE CRITERION .....	37
12.4 OPERATING CONDITION OF EUT .....	37
12.5 TEST PROCEDURE.....	38
12.6 TEST RESULT .....	38
<b>13. CONDUCTED SUSCEPTIBILITY TEST (EN 61000-4-6)</b> .....	<b>39</b>
13.1 BLOCK DIAGRAM OF TEST SETUP.....	39
13.2 TEST STANDARD .....	39
13.3 SEVERITY LEVELS AND PERFORMANCE CRITERION .....	39
13.4 OPERATING CONDITION OF EUT .....	39
13.5 TEST PROCEDURE.....	40
13.6 TEST RESULTS.....	40
<b>14. VOLTAGE DIPS, SHORT INTERRUPTIONS IMMUNITY TESTS (EN61000-4-11)</b> .....	<b>41</b>
14.1 BLOCK DIAGRAM OF TEST SETUP.....	41
14.2 TEST STANDARD .....	41
14.3 SEVERITY LEVELS AND PERFORMANCE CRITERION .....	41
14.4 EUT CONFIGURATION.....	41
14.5 OPERATING CONDITION OF EUT .....	41
14.6 TEST PROCEDURE.....	42
14.7 TEST RESULT .....	42
<b>15. TEST RESULTS</b> .....	<b>43</b>
15.1 EN 61000-4-2 ELECTROSTATIC DISCHARGE IMMUNITY TEST CONFIGURATION .....	43
15.2 EN 61000-4-3 ELECTROSTATIC DISCHARGE IMMUNITY TEST CONFIGURATION .....	43
15.3 EN 61000-4-4 ELECTRICAL FAST TRANSIENT/BURST IMMUNITY TEST CONFIGURATION .....	43
15.4 EN 61000-4-5 SURGE IMMUNITY TEST CONFIGURATION .....	43
15.5 EN 61000-4-6 CONDUCTED SUSCEPTIBILITY TEST CONFIGURATION.....	43
15.6 EN 61000-4-11 VOLTAGE DIPS, SHORT INTERRUPTIONS IMMUNITY TESTS CONFIGURATION.....	43
<b>APPENDIX A - PRODUCT LABELING</b> .....	<b>44</b>
CE MARK LABEL SPECIFICATION .....	44
<b>APPENDIX B - EUT PHOTOGRAPHS</b> .....	<b>45</b>

## 1. GENERAL INFORMATION

---

### 1.1 Product Description for Equipment Under Test (EUT)

#### General Description of E.U.T

EUT Description:	2 Wheel Auto - Balancing Electric Scooter
Trade Mark:	N/A
EUT Model No.:	Y1 (TIRE 6.5 INCH)
Supplementary Model:	Y4 (TIRE 10 INCH), Y2 (TIRE 6.5 INCH, Transformers shape + With Bluetooth), Y3 (TIRE 8 INCH, With Bluetooth, Fantastic sound & LED effect)Remark: supplementary models are only different in exterior with tested Model and with the same circuit construction. All the tests of this report are carried on Model Y1 (TIRE 6.5 INCH)
Test Voltage:	230V~, 50Hz

#### Remark:

- The test data gathered are from the production sample provided by the manufacturer.
- The length of power line is 1.8m

### 1.2 Test Standards

The following Declaration of Conformity report of EUT is prepared in accordance with

EN55014-1:2006+A1:2009 + A2:2011

EN 55014-2: 1997+A1: 2001+A2:2008

EN61000-3-2:2006+A1:2009+A2:2009

EN 61000-3-3: 2013

The objective of the manufacturer is to demonstrate compliance with the described standards above.

### 1.3 Test Summary

For the EUT described above. This apparatus is subdivided into category II according to the section 4.2 of EN55014-2:1997+A1:2001+A2:2008. So according to section 7.2.2 of this standard, the immunity test item applicable to this EUT is listed in table 3.

Table 1: Tests Carried Out Under EN55014-1:2006+A1:2009 + A2:2011 (as amended)

Standard	Test Items	Test Result
EN55014-1:2006+A1:2009+A2:2011	Conducted Emission, 150kHz to 30MHz	PASS
EN55014-1:2006+A1:2009+A2:2011	Disturbance Power (30MHz To 300MHz)	PASS
EN55014-1:2006+A1:2009+A2:2011	Click	N/A

- √ Indicates that the test is applicable  
 × Indicates that the test is not applicable

Table 2: Tests Carried Out Under EN61000-3-2:2006+A1:2009+A2:2009 & EN 61000-3-3: 2013

Standard	Test Items	Test Result
EN61000-3-2:2006+A1:2009 +A2:2009	Harmonic Current Test	PASS
EN 61000-3-3: 2013	Voltage Fluctuations and Flicker Test	PASS

- √ Indicates that the test is applicable  
 × Indicates that the test is not applicable

Table 3: Tests Carried Out Under EN55014-2:1997+A1:2001+A2:2008

Standard	Test Items	Test Result
EN 61000-4-2: 2009	Electrostatic discharge Immunity	PASS
EN61000-4-3: 2006 +A1:2008+A2:2010	Radiated Susceptibility (80MHz to 1GHz)	PASS
EN 61000-4-4: 2004+A1:2010	Electrical Fast Transient/Burst Immunity	PASS
EN 61000-4-5: 2006	Surge Immunity	PASS
EN 61000-4-6: 2009	Conducted Susceptibility (150kHz to 230MHz)	PASS
EN 61000-4-11: 2004	Voltage Dips, Short Interruptions Immunity	PASS

- √ Indicates that the test is applicable  
 × Indicates that the test is not applicable

### 1.4 Test Methodology

All measurements contained in this report were conducted with CISPR 16-1, radio disturbance and immunity measuring apparatus, and CISPR16-2, Method of measurement of disturbances and immunity.

All measurement required was performed at laboratory of Shenzhen POCE Technology Co., Ltd. at H Building, Hongfa Science and Technology Park, Tangtou, Shiyao, Bao'an District, Shenzhen, China

## 1.5 Test Facility

The test facility is recognized, certified, or accredited by the following organizations:

EMC Lab. : Accredited by FCC (Federal Communications Commission)  
June 08, 2010, the Certificate Registration Number is 222278.

Accredited by TMICO, Jun 11, 2010  
The Laboratory has been assessed according to the requirements ISO/IEC 17025.

Name of Firm : Shenzhen POCE Technology Co., Ltd.

The facility also complies with the radiated and AC line conducted test site criteria set forth in CISPR 16-1, CISPR16-2.

## 1.6 Test Equipment List and Details

Radiated Emission						
Item	Test Equipment	Manufacturer	Model No.	Inventory No.	Cal.Date (mm-dd-yy)	Cal.Due date (mm-dd-yy)
1	3m Semi- Anechoic Chamber	ZhongYu Electron	9.0(L)*6.0(W)* 6.0(H)	GTS250	Mar. 28 2014	Mar. 27 2015
2	Control Room	ZhongYu Electron	6.2(L)*2.5(W)* 2.4(H)	GTS251	N/A	N/A
3	ESU EMI Test Receiver	R&S	ESU26	GTS203	Jul. 06 2014	Jul. 05 2015
4	BiConiLog Antenna	SCHWARZBECK	VULB9163	GTS214	Mar. 08 2014	Mar. 07 2015
5	RF Amplifier	HP	8347A	GTS204	Jul. 06 2014	Jul. 05 2015
6	EMI Test Software	AUDIX	E3	N/A	N/A	N/A
7	Coaxial cable	GTS	N/A	GTS210	Jul. 06 2014	Jul. 05 2015
8	Coaxial Cable	GTS	N/A	GTS211	Jul. 06 2014	Jul. 05 2015
9	Thermo meter	KTJ	TA328	GTS256	Jul. 06 2014	Jul. 05 2015

Conducted Emission						
Item	Test Equipment	Manufacturer	Model No.	Inventory No.	Cal.Date (mm-dd-yy)	Cal.Due date (mm-dd-yy)
1	Shielding Room	ZhongYu Electron	7.3(L)x3.1(W)x2.9(H)	GTS252	Sep. 07 2014	Sep. 06 2015
2	EMI Test Receiver	R&S	ESCS30	GTS223	Jun. 29 2014	Jun. 29 2015
3	Pulse Limiter	R&S	ESH3-Z2	GTS224	Jun. 29 2014	Jun. 29 2015
4	Coaxial Switch	ANRITSU CORP	MP59B	GTS225	Jun. 29 2014	Jun. 29 2015
5	Artificial Mains Network	SCHWARZBECK MESS	NSLK8127	GTS226	Jun. 29 2014	Jun. 29 2015
6	Coaxial Cable	GTS	N/A	GTS227	Jul. 07 2014	Jul. 06 2015
7	EMI Test Software	AUDIX	E3	N/A	N/A	N/A
8	Thermo meter	KTJ	TA328	GTS233	Jul. 01 2014	Jul. 01 2015

ESD						
Item	Test Equipment	Manufacturer	Model No.	Inventory No.	Cal.Date (mm-dd-yy)	Cal.Due date (mm-dd-yy)
1	ESD Simulator	EMPEK	ESD-2030A	GTS242	Jul. 03 2014	Jul. 03 2015
2	Thermo meter	KTJ	TA328	GTS243	Jul. 01 2014	Jul. 01 2015

Harmonic, Flicker						
Item	Test Equipment	Manufacturer	Model No.	Inventory No.	Cal.Date (mm-dd-yy)	Cal.Due date (mm-dd-yy)
1	Power Analyzer	EMTEST	DPA500	GTS235	Jun. 29 2014	Jun. 29 2015
2	AC Power Source	EMTEST	ACS500	GTS236	Jun. 29 2014	Jun. 29 2015
3	Test software	EMTEST	ACS	N/A	N/A	N/A
4	Thermo meter	KTJ	TA328	GTS256	Jul. 01 2014	Jul. 01 2015

Disturbance Power						
Item	Test Equipment	Manufacturer	Model No.	Inventory No.	Cal.Date (mm-dd-yy)	Cal.Due date (mm-dd-yy)
1	Shielding Room	ZhongYu Electron	7.3(L)x3.1(W)x2.9(H)	GTS252	Sep. 07 2014	Sep. 06 2015
2	EMI Test Receiver	R&S	ESCS30	GTS223	Jun. 29 2014	Jun. 29 2015
3	Coaxial Switch	ANRITSU CORP	MP59B	GTS225	Jun. 29 2014	Jun. 29 2015
4	Absorbing clamp	Liithi	MDS-21	GTS229	Jul. 02 2014	Jul. 02 2015
5	Coaxial Cable	GTS	N/A	GTS228	Jul. 07 2014	Jul. 06 2015
6	EMI Test Software	AUDIX	E3	N/A	N/A	N/A
7	Thermo meter	KTJ	TA328	GTS233	Jul. 01 2014	Jul. 01 2015

EFT, Surge, Voltage dips and Interruption						
Item	Test Equipment	Manufacturer	Model No.	Inventory No.	Cal.Date (mm-dd-yy)	Cal.Due date (mm-dd-yy)
1	EMTEST system	EMTEST	UCS500N	GTS239	Jun. 29 2014	Jun. 29 2015
2	Thermo meter	KTJ	TA328	GTS238	Jul. 01 2014	Jul. 01 2015

Conducted Immunity:						
Item	Test Equipment	Manufacturer	Model No.	Serial NO.	Cal.Due Date (mm-dd-yy)	
1	CW sine Generator	EMTEST	CWS500	0399-11	Jan. 18 2015	
2	CDN	EMTEST	CDN-M2	9907105C	Jan. 18 2015	
3	CDN	EMTEST	CDN-M3	9905170C	Jan. 18 2015	

General used equipment:						
Item	Test Equipment	Manufacturer	Model No.	Inventory No.	Cal.Date (dd-mm-yy)	Cal.Due date (dd-mm-yy)
1	Barometer	ChangChun	DYM3	GTS257	July 27 2014	July 27 2015

## 2. SYSTEM TEST CONFIGURATION

---

### 2.1 Justification

The system was configured for testing in a typical fashion (as normally used by a typical user).

### 2.2 EUT Exercise Software

The EUT exercising program used during radiated and conducted testing was designed to exercise the various system components in a manner similar to a typical use. The software offered by manufacture, can let the EUT being normal operation.

### 2.3 Special Accessories

As shown in section 2.5, interface cable used for compliance testing is shielded as normally supplied by ideo international industry co., limited. and its respective support equipment manufacturers.

### 2.4 Equipment Modifications

The EUT tested was not modified by POCE.

### 2.5 Configuration of Test System



### 2.6 Test Setup Diagram

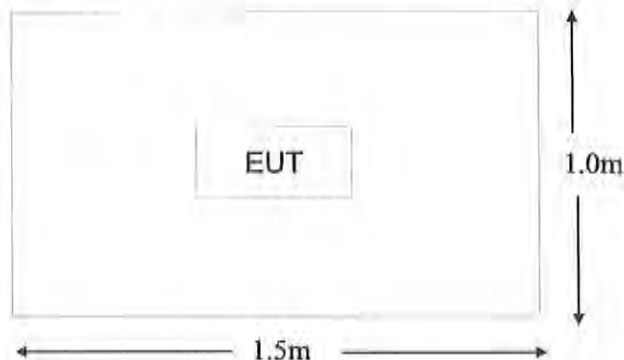





### 3.4 Instruments Setup

The test receiver was set with the following configurations:

Test Receiver Setting:

Frequency Range.....150 KHz to 30 MHz  
 Detector.....Peak & Quasi-Peak & Average  
 Sweep Speed.....Auto  
 IF Band Width.....9 KHz

### 3.5 Test Procedure

During the conducted emission test, the EUT power cord was connected to the auxiliary outlet of the first Artificial Mains.

Maximizing procedure was performed on the six (6) highest emissions to ensure EUT compliance using all installation combination.

All data was recorded in the peak detection mode. Quasi-peak and Average readings were only performed when an emission was found to be marginal (within -10 dB $\mu$ V of specification limits). Quasi-peak readings are distinguished with a "QP". Average readings are distinguished with a "AV".

### 3.6 Summary of Test Results

According to the data in section 3.6, the EUT complied with the EN 55014-1 Conducted margin.

### 3.7 Disturbance Voltage Test Data

Temperature ( °C )	22~25
Humidity ( %RH )	50~55
Barometric Pressure ( mbar )	950~1000
EUT	2 Wheel Auto - Balancing Electric Scooter
M/N	Y1 (TIRE 6.5 INCH)
Operating Mode	Normal

Test data see following pages

### 3.8 Test Result

Pass

Please refer to the following pages.

**Conducted Emission Test Data**

EUT: 2 Wheel Auto - Balancing Electric Scooter  
 M/N: Y1 (TIRE 6.5 INCH)  
 Operating Condition: Normal  
 Test Site: Shielded Room  
 Operator: Bill  
 Test Specification: AC 230V/50Hz  
 Comment: Line  
 Start of Test: 2014-04-11 Tem: 24°C Hum: 55%

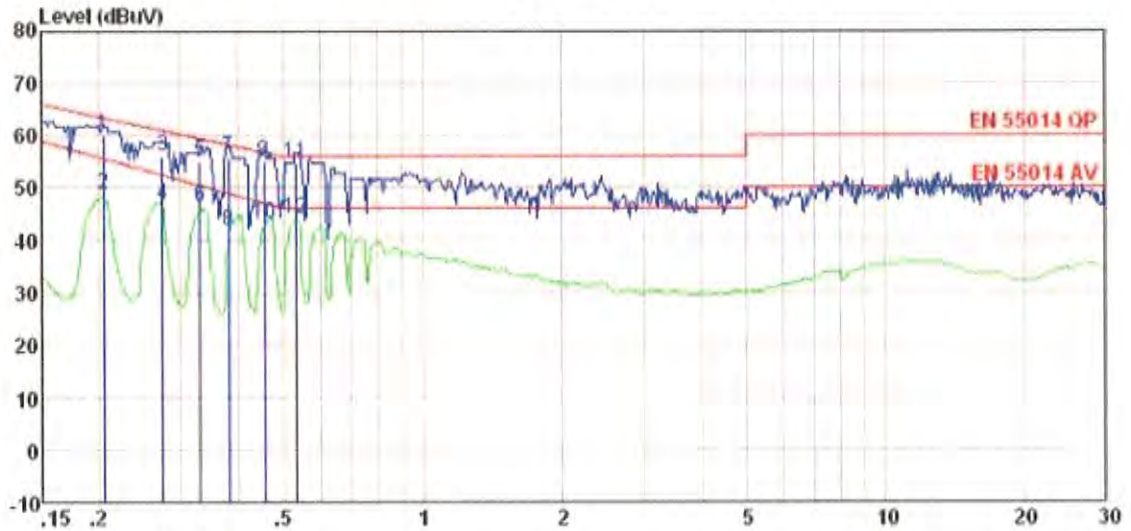

	Freq	Read Level	LISN Factor	Cable Loss	Level	Limit Line	Over Limit	Remark
	MHz	dBuV	dB	dB	dBuV	dBuV	dB	
1	0.205	59.85	0.13	0.13	60.11	63.40	-3.29	QP
2	0.205	48.39	0.13	0.13	48.65	55.62	-6.97	Average
3	0.274	55.76	0.11	0.10	55.97	60.98	-5.01	QP
4	0.274	46.62	0.11	0.10	46.83	52.48	-5.65	Average
5	0.330	54.72	0.11	0.10	54.93	59.44	-4.51	QP
6	0.330	46.10	0.11	0.10	46.31	50.48	-4.17	Average
7	0.381	55.67	0.11	0.10	55.88	58.25	-2.37	QP
8	0.381	41.54	0.11	0.10	41.75	48.93	-7.18	Average
9	0.454	54.72	0.12	0.11	54.95	56.80	-1.85	QP
10	0.454	43.02	0.12	0.11	43.25	47.04	-3.79	Average
11	0.532	54.56	0.13	0.11	54.80	56.00	-1.20	QP
12	0.532	43.78	0.13	0.11	44.02	46.00	-1.98	Average

**Conducted Emission Test Data**

EUT: 2 Wheel Auto - Balancing Electric Scooter  
 M/N: Y1 (TIRE 6.5 INCH)  
 Operating Condition: Operation  
 Test Site: Shielded Room  
 Operator: Bill  
 Test Specification: AC 230V/50Hz  
 Comment: Neutral  
 Start of Test: 2014-04-11      Tem: 24°C    Hum:55%

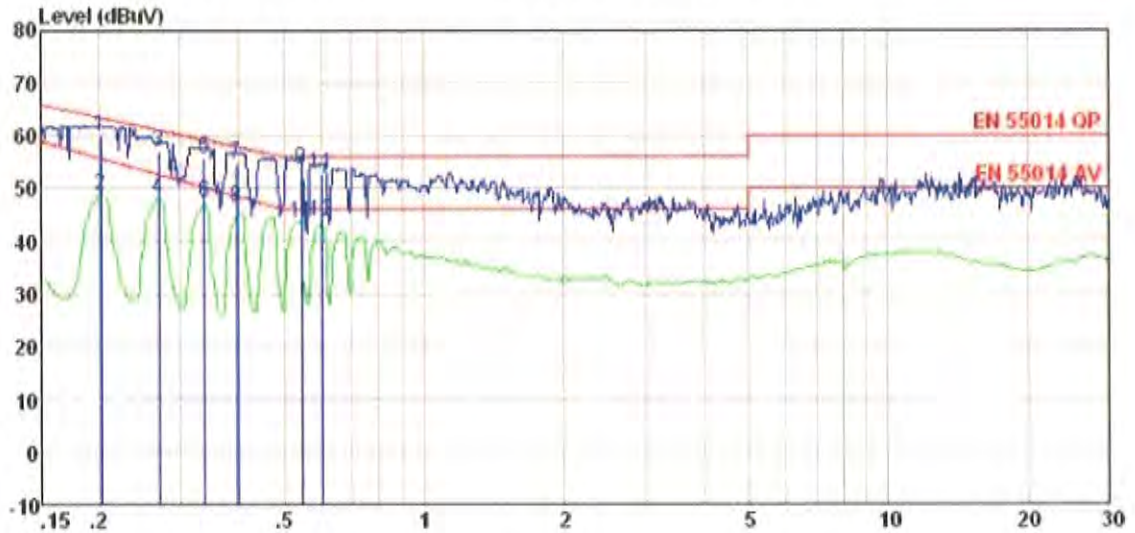

	Freq	Read Level	LISN Factor	Cable Loss	Level	Limit Line	Over Limit	Remark
	MHz	dBuV	dB	dB	dBuV	dBuV	dB	
1	0.202	59.83	0.07	0.13	60.03	63.54	-3.51	QP
2	0.202	48.73	0.07	0.13	48.93	55.80	-6.87	Average
3	0.269	56.79	0.06	0.11	56.96	61.16	-4.20	QP
4	0.269	48.08	0.06	0.11	48.25	52.71	-4.46	Average
5	0.336	55.75	0.06	0.10	55.91	59.31	-3.40	QP
6	0.336	47.14	0.06	0.10	47.30	50.30	-3.00	Average
7	0.396	54.51	0.06	0.11	54.68	57.95	-3.27	QP
8	0.396	46.17	0.06	0.11	46.34	48.53	-2.19	Average
9	0.546	53.66	0.07	0.11	53.84	56.00	-2.16	QP
10	0.546	43.31	0.07	0.11	43.49	46.00	-2.51	Average
11	0.601	52.60	0.07	0.12	52.79	56.00	-3.21	QP
12	0.601	43.52	0.07	0.12	43.71	46.00	-2.29	Average

## 4. DISCONTINUOUS DISTURBANCE (CLICK)

### 4.1 Limit of Discontinuous Disturbance

The limits for discontinuous disturbance depend mainly on the character of the disturbance and on the click rate **N** as given in details in clause 4.2.2 and 4.2.3 of the standard of EN 55014-1: 2006+A1:2009.

### 4.2 EUT Setup

The setup of EUT is according with CISPR 16-1, CISPR16-2 measurement procedure. See following test setup figure. The specification used was the EN 55014-1 limits.

The spacing between the peripherals was 10 cm.

Maximum emission emitted from EUT was determined by manipulating the EUT, support equipment, interconnecting cables and varying the mode of operation and the levels in the final result of the test were recorded with the EUT running in the operating mode that maximum emission was emitted.

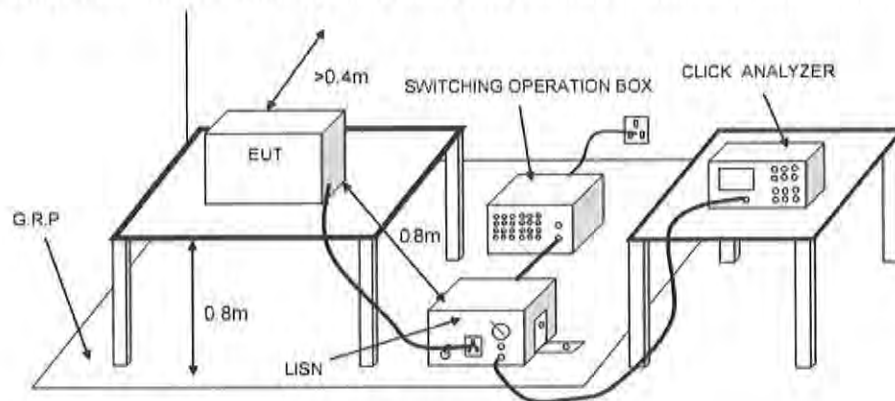

### 4.3 Test Procedure

During the Click test, the EUT power cord was connected to the auxiliary outlet of the first Artificial Mains Test Procedure details see clause 7.4.2 of standard EN 55014-1: 2006+A1:2009

### 4.4 Summary of Test Results

According to the data in section 4.3, the EUT complied with the requirement of Click test of EN 55014-1.

### 4.5 Disturbance Voltage Test Data

Temperature ( °C )	22~25
Humidity ( %RH )	50~54
Barometric Pressure ( mbar )	950~1000
EUT	N/A
M/N	N/A
Operating Mode	N/A

### 4.6 Test Result

N/A

## 5. DISTURBANCE POWER

### 5.1 Measurement Uncertainty

All measurements involve certain levels of uncertainties, especially in field of EMC. The factors contributing to uncertainties are spectrum analyzer, cable loss, and power clamp.

The Treatment of Uncertainty in EMC Measurements, the best estimate of the uncertainty of any conducted emissions measurement is  $\pm 2.4$  dB.

### 5.2 Limit of Disturbance Power

Frequency Range (MHz)	Limit (dBpW)	
	Quasi-Peak	Average
30~300	45~55	35~45

Note: (1) The limit line is a linear line.

### 5.3 EUT Setup

The setup of EUT is according with CISPR 16-1, CISPR16-2 measurement procedure. See following test setup figure. The specification used was the EN 55014-1 limits.

The EUT was placed at the edge of the test table so as to make the end of the lead close to the EUT as short as possible between the power clamp and the EUT.

The spacing between the peripherals was 10 cm.

Maximum emission emitted from EUT was determined by manipulating the EUT, support equipment, interconnecting cables and varying the mode of operation and the levels in the final result of the test were recorded with the EUT running in the operating mode that maximum emission was emitted

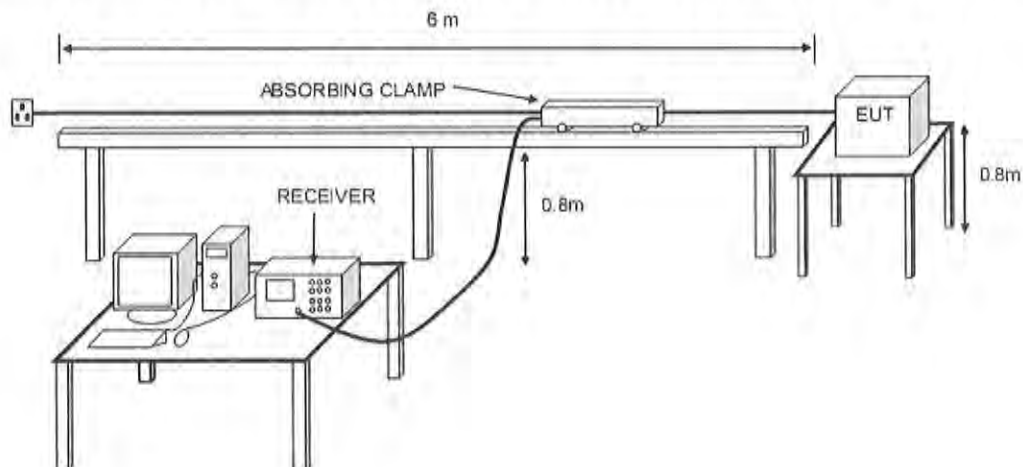

## 5.4 Instruments Setup

The test receiver was set with the following configurations:

Test Receiver Setting:

Frequency Range.....30MHz to 300 MHz  
 Detector.....Peak & Quasi-Peak & Average  
 Sweep Speed.....Auto  
 IF Band Width.....9 KHz

## 5.5 Test Procedure

The associated equipment under test is placed on a non-metallic table of 0.8 m of height above the floor and at least 0.4 m from other objects and from any person. The lead to be measured shall be stretched in a straight horizontal line for a length sufficient to accommodate the absorbing clamp and to permit the necessary adjustment of its position for tuning. The absorbing clamp is placed around the lead to be measured, with its current transformer towards the equipment under test, so as to measure a quantity proportional to the disturbance power on the lead.

Any other lead less than that to be measured shall either be disconnected, if mechanically and functionally possible, or fitted with ferrite rings to attenuate RF currents which may affect the measurement results. Such a lead shall be stretched away from the connected unit in a direction perpendicular to the direction of the lead to be measured.

All connectors not used shall be left un-terminated. All connectors having a connected lead shall be terminated in a manner representative of use. If the leads are screened and normally terminated in a screened unit, then the termination shall be screened.

## 5.6 Disturbance Power Test Data

Temperature ( °C )	22~23
Humidity ( %RH )	50~54
Barometric Pressure ( mbar )	950~1000
EUT	2 Wheel Auto - Balancing Electric Scooter
M/N	Y1 (TIRE 6.5 INCH)
Operating Mode	Normal

## 5.7 Test Plot(s) for Disturbance Power

Plot(s) of Disturbance Power Test Data is presented hereinafter as reference.

## 5.8 Test Result

Pass

Please refer to the following page.

**Power Clamp Test of EN 55014-1**

EUT: 2 Wheel Auto - Balancing Electric Scooter  
 M/N: Y1 (TIRE 6.5 INCH)  
 Operating Condition: Normal  
 Test Site: Shielded Room  
 Operator: Bill  
 Test Specification: AC 230V/50Hz  
 Comment: AC Line  
 Start of Test: 2014-11-17 Tem:25°C Hum:50%

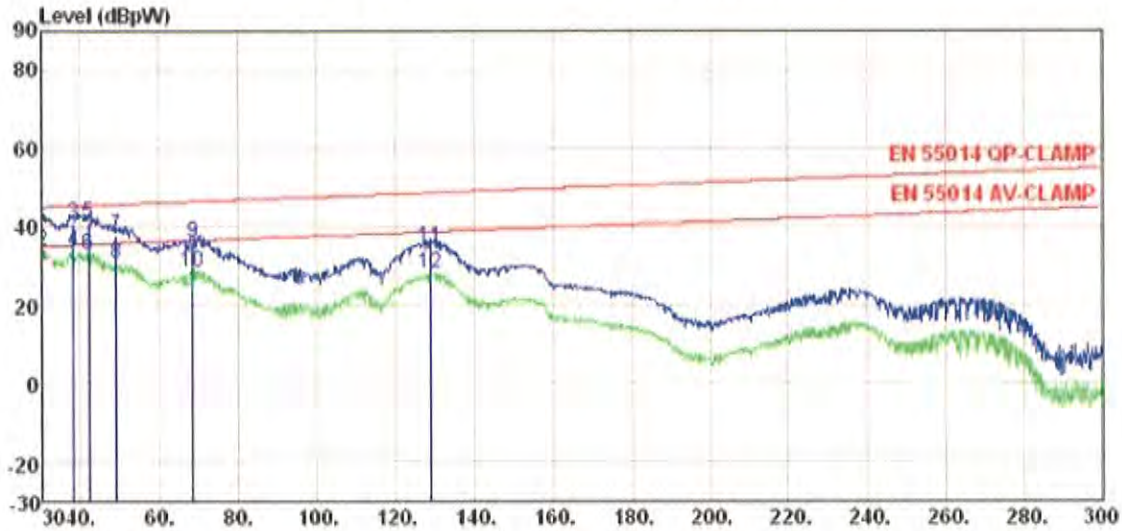

	Freq	Read Level	LISN Factor	Cable Loss	Level	Limit Line	Over Limit	Remark
	MHz	dBpW	dB	dB	dBpW	dBpW	dB	
1	30.000	21.58	18.89	0.89	41.36	45.01	-3.65	QP
2	30.000	14.03	18.89	0.89	33.81	35.01	-1.20	Average
3	38.100	20.72	19.52	0.81	41.05	45.31	-4.26	QP
4	38.100	13.45	19.52	0.81	33.78	35.31	-1.53	Average
5	41.880	20.62	19.59	0.83	41.04	45.45	-4.41	QP
6	41.880	12.49	19.59	0.83	32.91	35.45	-2.54	Average
7	48.900	17.32	19.51	1.05	37.88	45.71	-7.83	QP
8	48.900	10.28	19.51	1.05	30.84	35.71	-4.87	Average
9	68.340	17.13	17.71	1.03	35.87	46.43	-10.56	QP
10	68.340	9.76	17.71	1.03	28.50	36.43	-7.93	Average
11	129.090	14.46	18.56	1.75	34.77	48.68	-13.91	QP
12	129.090	7.91	18.56	1.75	28.22	38.68	-10.46	Average



**Power Clamp Test of EN 55014-1**

EUT: 2 Wheel Auto - Balancing Electric Scooter  
 M/N: Y1 (TIRE 6.5 INCH)  
 Operating Condition: Normal  
 Test Site: Shielded Room  
 Operator: Bill  
 Test Specification: AC 230V/50Hz  
 Comment: DC Line  
 Start of Test: 2014-11-17 Tem:25°C Hum:50%

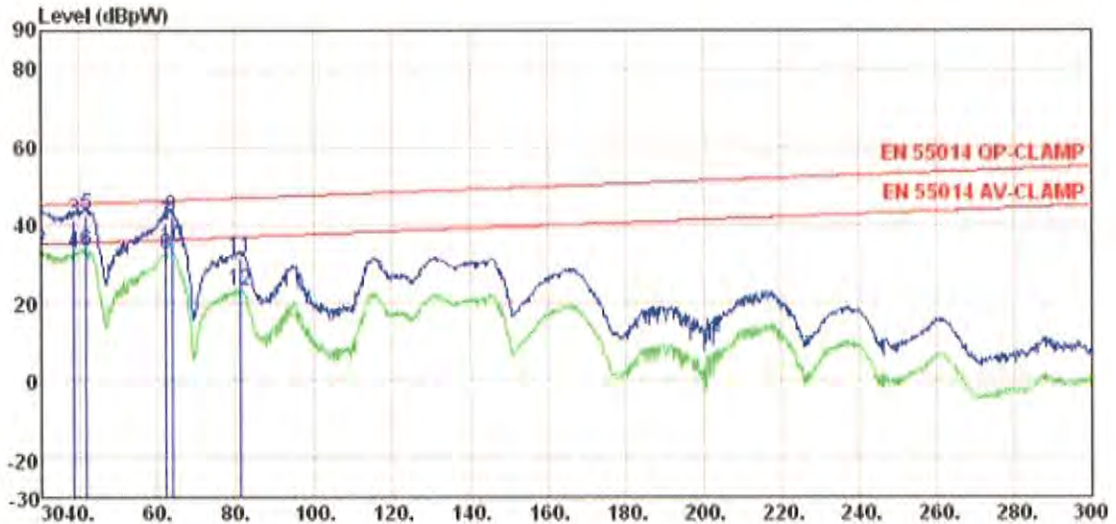

	Freq	Read Level	LISN Factor	Cable Loss	Level	Limit Line	Over Limit	Remark
	MHz	dBpW	dB	dB	dBpW	dBpW	dB	
1	30.000	22.75	18.89	0.89	42.53	45.01	-2.48	QP
2	30.000	13.42	18.89	0.89	33.20	35.01	-1.81	Average
3	38.640	21.01	19.54	0.81	41.36	45.33	-3.97	QP
4	38.640	12.63	19.54	0.81	32.98	35.33	-2.35	Average
5	41.610	22.05	19.59	0.83	42.47	45.44	-2.97	QP
6	41.610	13.03	19.59	0.83	33.45	35.44	-1.99	Average
7	62.130	20.72	18.83	0.97	40.52	46.20	-5.68	QP
8	62.130	12.55	18.83	0.97	32.35	36.20	-3.85	Average
9	63.750	22.40	18.61	0.98	41.99	46.26	-4.27	QP
10	63.750	14.77	18.61	0.98	34.36	36.26	-1.90	Average
11	81.030	13.07	16.76	1.51	31.34	46.90	-15.56	QP
12	81.030	4.94	16.76	1.51	23.21	36.90	-13.69	Average

## 6. RADIATED EMISSION MEASUREMENT

---

### 6.1 Block Diagram of Test

Block diagram of test setup (In chamber)

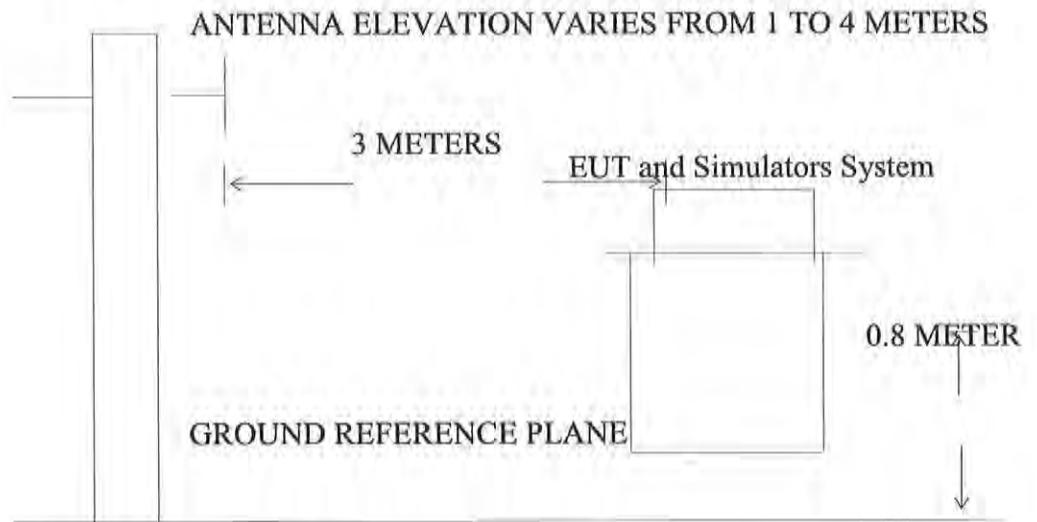

### 6.2 Measuring Standard

EN55014-1:2006+A1:2009+ A2:2011

### 6.3 Radiated Emission Limits

All emanations from a class B device or system, including any network of conductors and apparatus connected thereto, shall not exceed the level of field strengths specified below:

FREQUENCY (MHz)	DISTANCE (Meters)	FIELD STRENGTHS LIMIT (dB $\mu$ V/m)
30 ~ 230	3	40
230 ~ 1000	3	47

Note: (1) The smaller limit shall apply at the combination point between two frequency bands.

(2) Distance refers to the distance in meters between the measuring instrument antenna and the closed point of any part of the EUT.

### 6.4 EUT Configuration on Test

The EN61000-6-3 regulations test method must be used to find the maximum emission during radiated emission measurement.

### 6.5 Operating Condition of EUT

Turn on the power.

After that, let the EUT work in test mode (Normal) and measure it.

### 6.6 Test Procedure

The EUT is placed on a turn table which is 0.8 meter high above the ground. The turn table can rotate 360 degrees to determine the position of the maximum emission level. The EUT is set 3 meters away from the receiving antenna which is mounted on a antenna tower. The antenna can be moved up and down from 1 to 4 meters to find out the maximum emission level. Bilog antenna (calibrated by Dipole Antenna) is used as a receiving antenna. Both horizontal and vertical polarization of the antenna are set on test.

The bandwidth of the Receiver (ESCS30) is set at ES1kHz.  
The frequency range from 30MHz to 1000MHz is investigated.

### 6.7 Measuring Results

**PASS.**

Please reference to the following pages

Standard:	EN55014-1:2006+A1:2009+ A2:2011	Polarization:	Horizontal
Test item:	Radiation Test	Date:	2014-11-17
EUT:	2 Wheel Auto - Balancing Electric Scooter	Test By:	Bill
Model:	Y1 (TIRE 6.5 INCH)	Distance:	3m
Note:			

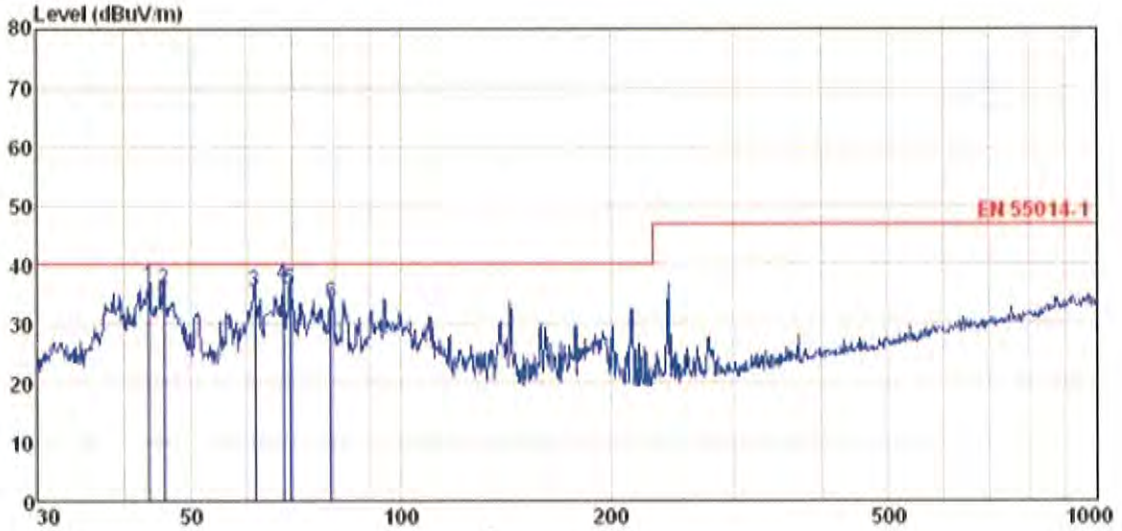

	Freq	ReadAntenna	Cable Preamp	Level	Limit	Over	Remark	
	MHz	Level	Factor	Loss	Factor	Level	Line	
		dBuV	dB/m	dB	dB	dBuV/m	dBuV/m	
1	43.506	51.94	15.56	0.70	32.02	36.18	40.00	-3.82 QP
2	45.695	51.61	15.51	0.73	32.00	35.85	40.00	-4.15 QP
3	61.778	52.46	14.03	0.87	31.93	35.43	40.00	-4.57 QP
4	67.675	56.01	11.61	0.92	31.89	36.65	40.00	-3.35 QP
5	69.357	55.86	10.92	0.94	31.88	35.84	40.00	-4.16 QP
6	79.521	53.60	10.48	1.02	31.76	33.34	40.00	-6.66 QP

Standard:	EN55014-1:2006+A1:2009+ A2:2011	Polarization:	Vertical
Test item:	Radiation Test	Date:	2014-11-17
EUT:	2 Wheel Auto - Balancing Electric Scooter	Test By:	Bill
Model:	Y1 (TIRE 6.5 INCH)	Distance:	3m
Note:			

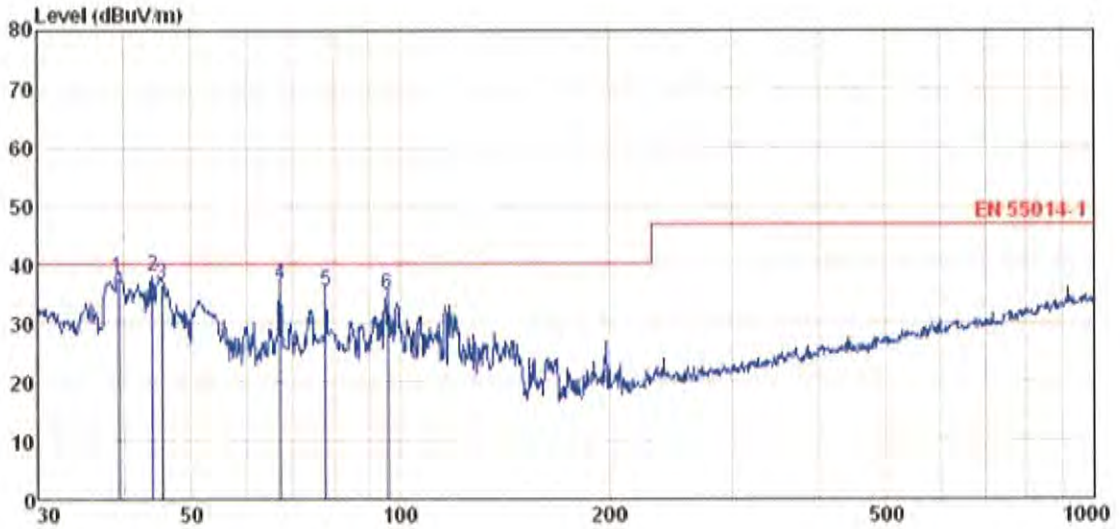

	Freq	ReadAntenna	Cable	Preamp	Level	Limit	Over	Remark
	MHz	Level	Factor	Loss	Factor	Line	Limit	
		dBuV	dB/m	dB	dB	dBuV/m	dBuV/m	dB
1	39.299	53.83	15.39	0.65	32.06	37.81	40.00	-2.19 QP
2	43.966	53.95	15.56	0.71	32.02	38.20	40.00	-1.80 QP
3	45.375	52.45	15.54	0.72	32.00	36.71	40.00	-3.29 QP
4	67.202	55.73	11.75	0.92	31.90	36.50	40.00	-3.50 QP
5	78.139	55.75	10.31	1.01	31.78	35.29	40.00	-4.71 QP
6	95.762	50.64	14.90	1.16	31.74	34.96	40.00	-5.04 QP

## 7. HARMONIC CURRENT TEST (EN 61000-3-2)

---

### 7.1 Application of Harmonic Current Emission

Compliance to these standards ensures that tested equipment will not generate harmonic currents at levels that cause unacceptable degradation of the main environment. This directly contributes to meeting compatibility levels established in other EMC standards, which defines compatibility levels for low-frequency conducted disturbances in low-voltage supply systems.

### 7.2 Measurement Data

Note: For detailed test data, refer to the following pages:

Standard used	EN/IEC 61000-3-2 Quasi-stationary – Equipment class A
Observation time	150s
Windows width:	10 periods - (EN/IEC 61000-4-7 Edition 2000)
EUT	2 Wheel Auto - Balancing Electric Scooter
M/N	Y1 (TIRE 6.5 INCH)
Operating Mode	Normal

### 7.3 Test Results

Pass

Please refer to the following pages.

**Average harmonic current results**

EUT: 2 Wheel Auto - Balancing Electric Scooter M/N: Y1 (TIRE 6.5 INCH) Tested by: Bill  
 Test category: Class-A per A-14 (European limits) Test Margin: 100  
 Test date: 2014-04-11 Start time: 15:05:17 End time: 15:08:57  
 Test duration (min): 2.5 Data file name: H-000167.cts\_data  
 Comment: Normal Temp:25.3°C Humi:54%

Hn	Ieff [A]	% of Limit	Limit [A]	Result
1	122.988E-3			
2	918.960E-6	0.085	1.09	PASS
3	118.113E-3	5.135	2.30	PASS
4	1.896E-3	0.441	430.00E-3	PASS
5	112.228E-3	9.945	1.14	PASS
6	1.189E-3	0.390	300.00E-3	PASS
7	103.516E-3	13.444	770.00E-3	PASS
8	1.368E-3	0.595	230.00E-3	PASS
9	92.867E-3	23.217	400.00E-3	PASS
10	1.360E-3	0.739	184.00E-3	PASS
11	80.713E-3	24.458	330.00E-3	PASS
12	977.260E-6	0.637	153.33E-3	PASS
13	67.747E-3	32.280	210.00E-3	PASS
14	1.185E-3	0.888	131.43E-3	PASS
15	64.676E-3	38.384	150.00E-3	PASS
16	950.139E-6	0.828	115.00E-3	PASS
17	41.922E-3	31.675	132.35E-3	PASS
18	1.182E-3	1.168	102.22E-3	PASS
19	30.381E-3	25.655	118.42E-3	PASS
20	879.096E-6	0.968	92.00E-3	PASS
21	20.570E-3	12.800	160.71E-3	PASS
22	825.780E-6	0.987	83.84E-3	PASS
23	13.327E-3	9.082	146.74E-3	PASS
24	838.468E-6	1.094	76.66E-3	PASS
25	9.484E-3	7.025	135.00E-3	PASS
26	774.390E-6	1.094	70.77E-3	PASS
27	9.180E-3	7.344	124.99E-3	PASS
28	1.477E-3	2.248	65.71E-3	PASS
29	10.186E-3	8.761	116.39E-3	PASS
30	790.731E-6	1.289	61.33E-3	PASS
31	10.768E-3	9.891	108.87E-3	PASS
32	1.283E-3	2.231	57.50E-3	PASS
33	10.448E-3	10.216	102.27E-3	PASS
34	784.431E-6	1.449	54.12E-3	PASS
35	9.285E-3	9.628	96.44E-3	PASS
36	782.824E-6	1.493	51.11E-3	PASS
37	7.686E-3	8.407	91.21E-3	PASS
38	787.794E-6	1.588	48.42E-3	PASS
39	5.699E-3	6.588	86.63E-3	PASS
40	752.131E-6	1.635	46.00E-3	PASS

**Maximum harmonic current results**

EUT: 2 Wheel Auto - Balancing Electric Scooter

M/N: Y1 (TIRE 6.5 INCH)

Tested by: Bill

Test category: Class-A per A-14 (European limits)

Test Margin: 100

Test date: 2014-04-11

Start time: 15:05:17

End time: 15:08:57

Test duration (min): 2.5

Data file name: H-000168.cts\_data

Comment: Normal

Temp:25.3°C

Humi:54%

Hn	Ieff [A]	% of Limit	Limit [A]	Result
1	148.087E-3			
2	2.235E-3	0.138	1.62	PASS
3	142.308E-3	4.125	3.45	PASS
4	2.643E-3	0.410	645.00E-3	PASS
5	134.482E-3	7.864	1.71	PASS
6	1.953E-3	0.434	450.00E-3	PASS
7	122.901E-3	10.641	1.15	PASS
8	1.741E-3	0.505	345.00E-3	PASS
9	108.934E-3	18.156	600.00E-3	PASS
10	1.697E-3	0.615	276.00E-3	PASS
11	93.124E-3	18.813	495.00E-3	PASS
12	1.567E-3	0.681	229.99E-3	PASS
13	76.552E-3	24.302	315.00E-3	PASS
14	1.756E-3	0.891	197.15E-3	PASS
15	60.086E-3	26.696	225.00E-3	PASS
16	1.614E-3	0.935	172.50E-3	PASS
17	45.088E-3	22.712	198.52E-3	PASS
18	1.758E-3	1.147	153.33E-3	PASS
19	31.822E-3	17.915	177.63E-3	PASS
20	1.614E-3	1.170	138.00E-3	PASS
21	21.911E-3	13.634	160.71E-3	PASS
22	1.433E-3	1.142	125.46E-3	PASS
23	14.546E-3	9.912	146.74E-3	PASS
24	1.405E-3	1.222	114.99E-3	PASS
25	11.590E-3	8.586	135.00E-3	PASS
26	1.254E-3	1.182	106.16E-3	PASS
27	12.678E-3	10.143	124.99E-3	PASS
28	1.894E-3	1.922	98.57E-3	PASS
29	13.581E-3	11.651	116.39E-3	PASS
30	1.378E-3	1.498	92.00E-3	PASS
31	13.257E-3	12.177	108.87E-3	PASS
32	1.757E-3	2.037	86.25E-3	PASS
33	11.972E-3	11.608	102.27E-3	PASS
34	1.383E-3	1.703	81.18E-3	PASS
35	9.848E-3	10.212	96.44E-3	PASS
36	1.353E-3	1.765	76.66E-3	PASS
37	8.276E-3	9.073	91.21E-3	PASS
38	1.239E-3	1.705	72.63E-3	PASS
39	8.198E-3	7.162	86.53E-3	PASS
40	1.151E-3	1.669	69.00E-3	PASS



**Maximum harmonic voltage results**EUT: 2 Wheel Auto - Balancing Electric Scooter  
Bill

M/N: Y1 (TIRE 6.5 INCH)

Tested by:

Test category: Class-A per A-14 (European limits)

Test Margin: 100

Test date: 2014-04-11

Start time: 15:05:17

End time: 15:08:57

Test duration (min): 2.5

Data file name: H-000169.cts\_data

Comment: Normal

Temp:25.3°C

Humi:54%

Hn	Ueff [V]	Ueff [%]	Limit [%]	Result
1	232.44	101.059		
2	45.33E-3	0.020	0.2	PASS
3	155.03E-3	0.067	0.9	PASS
4	20.85E-3	0.009	0.2	PASS
5	81.91E-3	0.027	0.4	PASS
6	17.49E-3	0.008	0.2	PASS
7	128.84E-3	0.056	0.3	PASS
8	15.22E-3	0.007	0.2	PASS
9	112.56E-3	0.049	0.2	PASS
10	24.21E-3	0.011	0.2	PASS
11	115.63E-3	0.050	0.1	PASS
12	24.27E-3	0.011	0.1	PASS
13	95.15E-3	0.041	0.1	PASS
14	19.35E-3	0.008	0.1	PASS
15	132.56E-3	0.058	0.1	PASS
16	14.48E-3	0.006	0.1	PASS
17	50.03E-3	0.022	0.1	PASS
18	10.37E-3	0.005	0.1	PASS
19	28.97E-3	0.013	0.1	PASS
20	12.94E-3	0.006	0.1	PASS
21	91.41E-3	0.040	0.1	PASS
22	14.89E-3	0.006	0.1	PASS
23	78.99E-3	0.034	0.1	PASS
24	13.08E-3	0.006	0.1	PASS
25	38.62E-3	0.017	0.1	PASS
26	11.81E-3	0.005	0.1	PASS
27	24.93E-3	0.011	0.1	PASS
28	14.78E-3	0.006	0.1	PASS
29	65.48E-3	0.028	0.1	PASS
30	13.27E-3	0.006	0.1	PASS
31	66.39E-3	0.029	0.1	PASS
32	13.63E-3	0.006	0.1	PASS
33	48.10E-3	0.021	0.1	PASS
34	13.13E-3	0.006	0.1	PASS
35	27.75E-3	0.012	0.1	PASS
36	14.04E-3	0.006	0.1	PASS
37	49.79E-3	0.022	0.1	PASS
38	12.36E-3	0.005	0.1	PASS
39	40.70E-3	0.018	0.1	PASS
40	11.34E-3	0.005	0.1	PASS

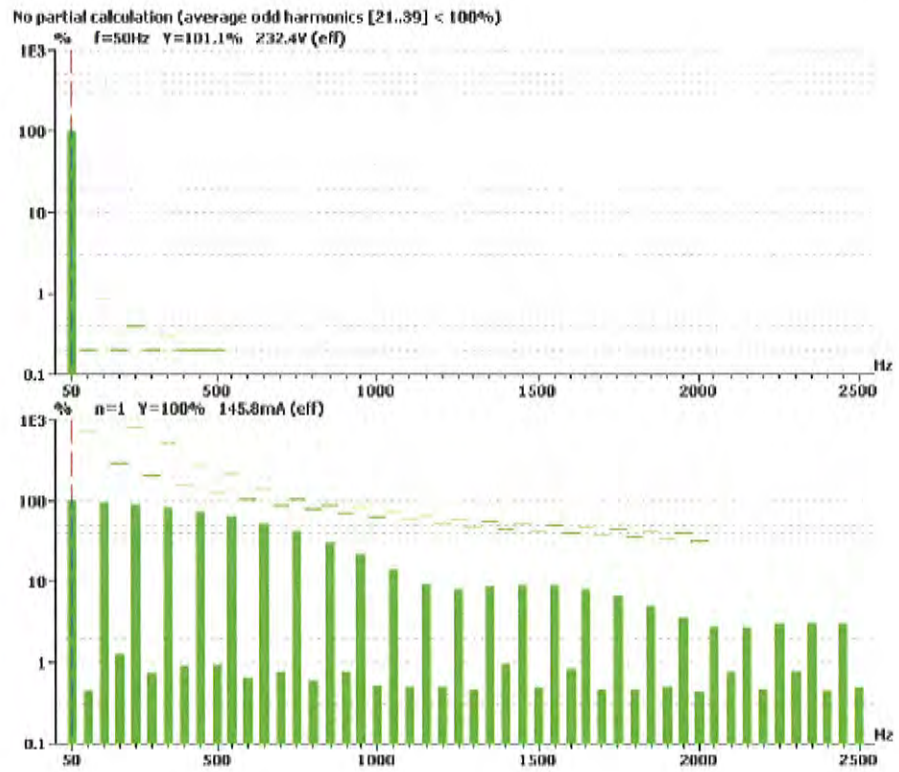

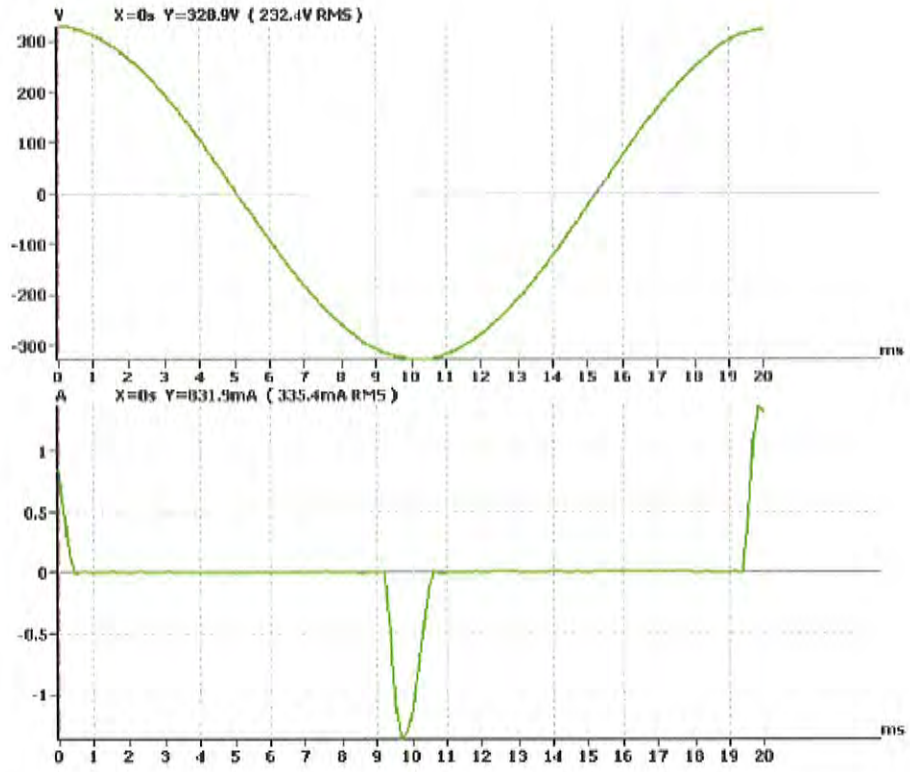

## 8. VOLTAGE FLUCTUATIONS AND FLICKER TEST (EN 61000-3-3)

### 8.1 Application of Voltage Fluctuations and Flicker Test

Compliance to these standards ensures that tested equipment will not generate flickers and voltage change at levels that cause unacceptable degradation of the main environment. This directly contributes to meeting compatibility levels established in other EMC standards, which defines compatibility levels for low-frequency conducted disturbances in low-voltage supply systems.

### 8.2 Measurement Data

Standard used	EN/IEC 61000-3-3 Flicker
Short time (Pst)	10 min
Observation time	10 min (1 Flickers measurement)
Flickermeter	AC 230V / 50Hz
EUT	2 Wheel Auto - Balancing Electric Scooter
M/N	Y1 (TIRE 6.5 INCH)
Operating Mode	Normal

### 8.3 Test Results

PASS

Type of Test:	Flickermeter Test - Table
Power Analyzer:	Voltech PM6000 SN: 200006700433 Firmware Version v1.21.07RC2
Channel(s):	1. SN:090015500321, 28 Adjusted Date: 30 SEP 2010 2. SN:None Adjusted Date:None 3. SN:None Adjusted Date:None 4. SN:None Adjusted Date:None 5. SN:None Adjusted Date:None 6. SN:None Adjusted Date:None
Shunt(s):	1. SN:091024301317, 4 Adjusted Date: 1 OCT 2010 2. SN:None Adjusted Date:None 3. SN:None Adjusted Date:None 4. SN:None Adjusted Date:None 5. SN:None Adjusted Date:None 6. SN:None Adjusted Date:None
AC Source:	Mains / Manual Source
Overall Result:	Notes: Measurement method - Voltage
<b>PASS</b>	

	Pst	dc (%)	dmax (%)	d(t) > 3.3%(ms)
Limit	1.000	3.300	4.000	500
Reading 1	0.089	0.021	0.311	0

## 9. ELECTROSTATIC DISCHARGE IMMUNITY TEST (EN 61000-4-2)

### 9.1 Block Diagram of Test Setup

#### 9.1.1 Block diagram of connection between the EUT and Load

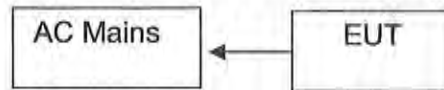

(EUT: 2 Wheel Auto - Balancing Electric Scooter)

#### 9.1.2 Block diagram of ESD test setup

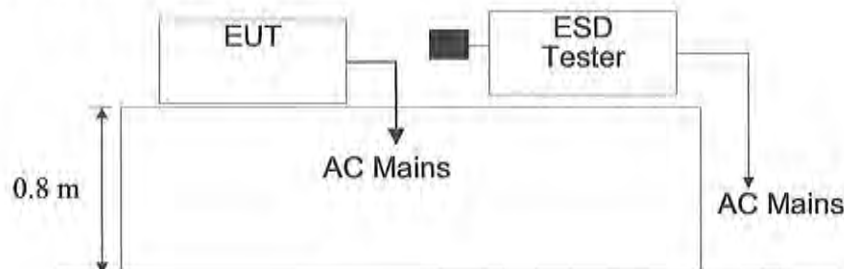

### 9.2 Test Standard

EN 55014-2: 1997+A1:2001+A2:2008, (EN61000-4-2: 2009 Severity Level: 3 / Air Discharge:  $\pm 8$ KV Level: 2 / Contact Discharge:  $\pm 4$ KV)

### 9.3 Severity Levels and Performance Criterion

#### 9.3.1 Severity level

Level	Test Voltage Contact Discharge (KV)	Test Voltage Air Discharge (KV)
1	$\pm 2$	$\pm 2$
2	$\pm 4$	$\pm 4$
3	$\pm 6$	$\pm 8$
4	$\pm 8$	$\pm 15$
X	Special	Special

#### 9.3.2 Performance criterion: B

### 9.4 Operating Condition of EUT

9.4.1 Setup the EUT as shown on Section 8.1.

9.4.2 Turn on the power of all equipments.

9.4.3 Let the EUT work in measuring mode (Normal) and measure it.

## 9.5 Test Procedure

### 9.5.1 Air Discharge:

This test is done on a non-conductive surface. The round discharge tip of the discharge electrode shall be approached as fast as possible to touch the EUT. After each discharge, the discharge electrode shall be removed from the EUT. The generator is then re-triggered for a new single discharge and repeated 10 times for each pre-selected test point. This procedure shall be repeated until all the air discharge completed.

### 9.5.2 Contact Discharge:

All the procedure shall be same as Section 8.5.1. Except that the tip of the discharge electrode shall touch the EUT before the discharge switch is operated.

### 9.5.3 Indirect discharge for horizontal coupling plane

At least 10 single discharges (in the most sensitive polarity) shall be applied at the front edge of each HCP opposite the center point of each unit (if applicable) of the EUT and 0.1m from the front of the EUT. The long axis of the discharge electrode shall be in the plane of the HCP and perpendicular to its front edge during the discharge.

### 9.5.4 Indirect discharge for vertical coupling plane

At least 10 single discharge (in the most sensitive polarity) shall be applied to the center of one vertical edge of the coupling plane. The coupling plane, of dimensions 0.5m X 0.5m, is placed parallel to, and positioned at a distance of 0.1m from the EUT. Discharges shall be applied to the coupling plane, with this plane in sufficient different positions that the four faces of the EUT are completely illuminated.

## 9.6 Test Results

PASS

Please refer to the following page.

Temperature ( °C )	22~23
Humidity ( %RH )	50~54
Barometric Pressure ( mbar )	950~1000
EUT	2 Wheel Auto - Balancing Electric Scooter
M/N	Y1 (TIRE 6.5 INCH)
Operating Mode	Normal

Table 1: Electrostatic Discharge Immunity (Air Discharge)

EN 61000-4-2 Test Points	Test Levels									
	-2 kV	+2 kV	-4 kV	+4 kV	-6 kV	+6 kV	-8 kV	+8 kV	-15 kV	+15 kV
All Seams	A	A	A	A	A	A	A	A	/	/
Buttons	A	A	A	A	A	A	A	A	/	/

Table 2: Electrostatic Discharge Immunity (Direct Contact)

EN 61000-4-2 Test Points	Test Levels									
	-2 kV	+2 kV	-4 kV	+4 kV	-6 kV	+6 kV	-8 kV	+8 kV	-15 kV	+15 kV
Metal Cover	A	A	A	A	/	/	/	/	/	/

Table 3: Electrostatic Discharge Immunity (Indirect Contact HCP)

EN 61000-4-2 Test Points	Test Levels									
	-2 kV	+2 kV	-4 kV	+4 kV	-6 kV	+6 kV	-8 kV	+8 kV	-15 kV	+15 kV
Front Side	A	A	A	A	/	/	/	/	/	/
Top Side	A	A	A	A	/	/	/	/	/	/
Back Side	A	A	A	A	/	/	/	/	/	/
Left Side	A	A	A	A	/	/	/	/	/	/
Right Side	A	A	A	A	/	/	/	/	/	/

Table 4: Electrostatic Discharge Immunity (Indirect Contact VCP)

EN 61000-4-2 Test Points	Test Levels									
	-2 kV	+2 kV	-4 kV	+4 kV	-6 kV	+6 kV	-8 kV	+8 kV	-15 kV	+15 kV
Front Side	A	A	A	A	/	/	/	/	/	/
Top Side	A	A	A	A	/	/	/	/	/	/
Back Side	A	A	A	A	/	/	/	/	/	/
Left Side	A	A	A	A	/	/	/	/	/	/
Right Side	A	A	A	A	/	/	/	/	/	/

## 10.0 RF FIELD STRENGTH SUSCEPTIBILITY TEST

### 10.1 Block Diagram of Test

#### 10.1.1 Block diagram of connection between the EUT and Load



#### 10.1.2 Block diagram of RS test setup

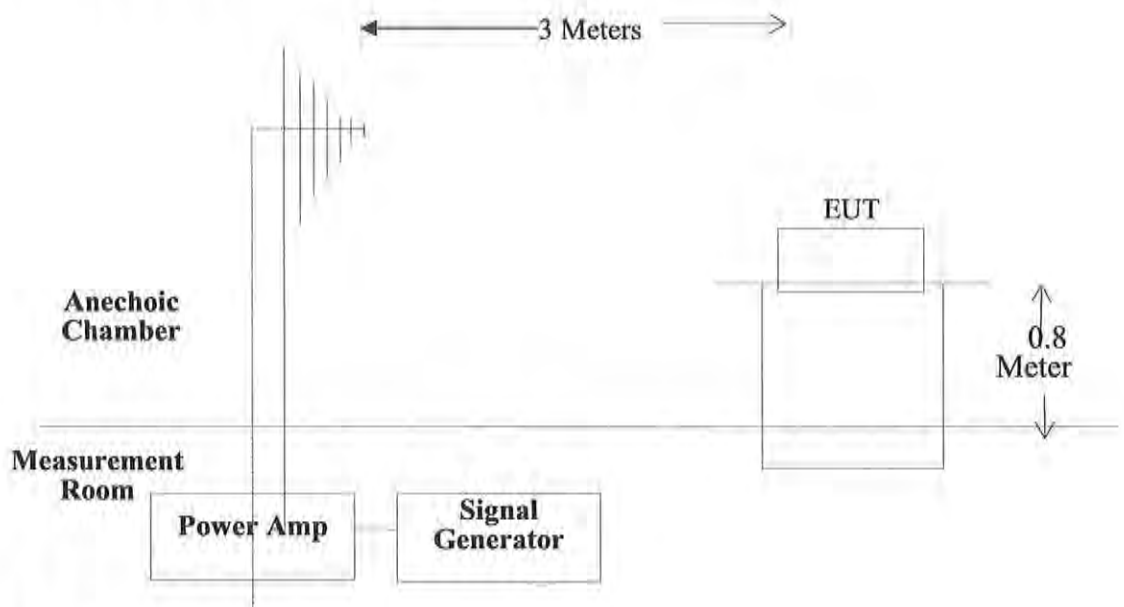

### 10.2 Test Standard

EN55014-2:1997+A1:2001+A2:2008

(EN61000-4-3:2006 +A1:2008+A2:2010 (Severity Level: 2, 3V / m))



### 10.3 Severity Levels and Performance Criterion

#### 10.3.1 Severity Levels

Level	Field Strength V/m
1.	1
2.	3
3.	10
X	Special

#### 10.3.2 Performance Criterion : A

### 10.4 EUT Configuration on Test

The configuration of the EUT is same as Section 3.3.

### 10.5 Operating Condition of EUT

Same as radiated emission measurement which is listed in Section 3.4, except the test setup replaced as Section 8.1.

### 10.6 Test Procedure

The EUT are placed on a table which is 0.8 meter high above the ground. The EUT is set 3 meters away from the transmitting antenna which is mounted on an antenna tower. Both horizontal and vertical polarization of the antenna are set on test. Each of the four sides of the EUT must be faced this transmitting antenna and measured individually.

In order to judge the EUT performance, a CCD camera is used to monitor its screen. All the scanning conditions are as following:

Condition of Test	Remark
1. Fielded Strength	3V/m (Severity Level 2)
2. Radiated Signal	Modulated
3. Scanning Frequency	80-1000MHz
4. Sweep time of radiated	0.0015 Decade/s
5. Dwell Time	1 Sec.

### 10.7 Test Results

**PASS.** Please refer to the following page.



## 11. ELECTRICAL FAST TRANSIENT/BURST IMMUNITY TEST (EN 61000-4-4)

### 11.1 Block Diagram of Test Setup

#### 11.1.1. Block Diagram of the EUT

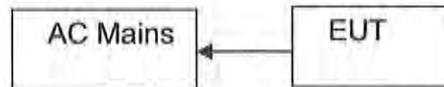

(EUT: 2 Wheel Auto - Balancing Electric Scooter)

#### 11.1.2. Block Diagram of the AC Mains

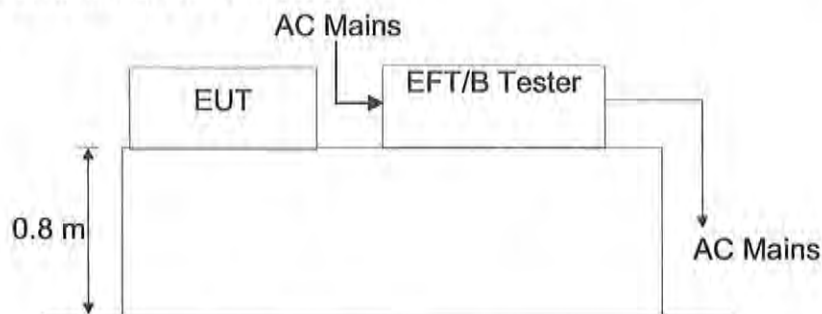

(EUT: 2 Wheel Auto - Balancing Electric Scooter)

### 11.2 Test Standard

EN 55014-2:1997+A1:2001+A2:2008, (EN61000-4-4: 2004+A1: 2010, Severity Level, Level 2: 1KV)

### 11.3 Severity Levels and Performance Criterion

#### 11.3.1 Severity level

Open Circuit Output Test Voltage $\pm 10\%$		
Level	On 2 Wheel Auto - Balancing Electric Scooter Lines	On I/O (Input/Output) Signal data and control lines
1	0.5 KV	0.25 KV
2	1 KV	0.5 KV
3	2 KV	1 KV
4	4 KV	2 KV
X	Special	Special

#### 11.3.2 Performance criterion: B

### 11.4 Operating Condition of EUT

11.4.1 Setup the EUT as shown in Section 9.1.

11.4.2 Turn on the power of all equipments.

11.4.3 Let the EUT work in test mode (Normal) and measure it.

## 11.5 Test Procedure

The EUT is put on the table which is 0.8 meter high above the ground. This reference ground plane shall project beyond the EUT by at least 0.1m on all sides and the minimum distance between EUT and all other conductive structure, except the ground plane beneath the EUT, shall be more than 0.5m.

11.5.1 For input and output AC power ports:  
It's unnecessary to test

11.5.2 For signal lines and control lines ports:  
It's unnecessary to test.

11.5.3 For DC Input line ports:

The EUT is connected to the DC power mains by using a coupling device which couples the EFT interference signal to DC power lines. Both polarities of the test voltage should be applied during compliance test and the duration of the test is 2 mins.

## 11.6 Test Result

PASS

Temperature ( °C )	22~23
Humidity ( %RH )	50~54
Barometric Pressure ( mbar )	950~1000
EUT	2 Wheel Auto - Balancing Electric Scooter
M/N	Y1 (TIRE 6.5 INCH)
Operating Mode	Normal

EN 61000-4-4 Test Points		Test Levels (kV)							
		+0.5	-0.5	+1.0	-1.0	+2.0	-2.0	+4.0	-4.0
Power Supply Power Line of EUT	L1	A	A	A	A	/	/	/	/
	N	A	A	A	A	/	/	/	/
	Earth	/	/	/	/	/	/	/	/
	L1+N	A	A	A	A	/	/	/	/
	L1 + Earth	/	/	/	/	/	/	/	/
	N+ Earth	/	/	/	/	/	/	/	/
	L1+N+Earth	/	/	/	/	/	/	/	/

## 12. SURGE IMMUNITY TEST (EN 61000-4-5)

### 12.1 Block Diagram of Test Setup

#### 12.1.1. Block Diagram of the EUT

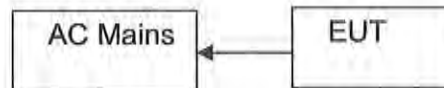

(EUT: 2 Wheel Auto - Balancing Electric Scooter)

#### 12.1.2. Block Diagram of the AC Mains

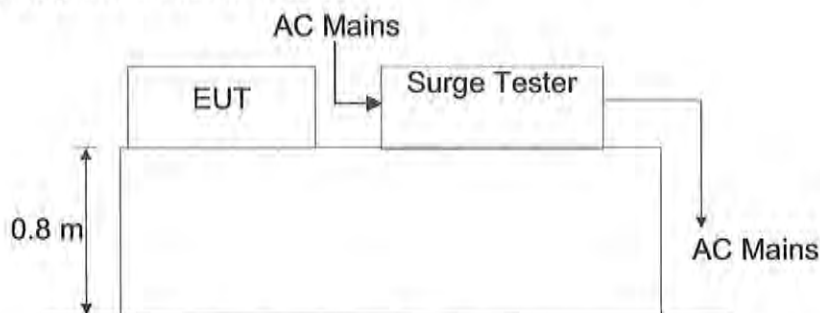

(EUT: 2 Wheel Auto - Balancing Electric Scooter)

### 12.2 Test Standard

EN 55014-2: 1997+A1:2001+A2:2008, (EN61000-4-5: 2006 Severity Level: Line to Line, Level 2: 1KV, Line to Earth, Level 3: 2KV)

### 12.3 Severity Levels and Performance Criterion

#### 12.3.1. Severity level

Severity Level	Open-Circuit Test Voltage KV
1	0.5
2	1.0
3	2.0
4	4.0
*	Special

#### 12.3.2 Performance criterion: B

### 12.4 Operating Condition of EUT

12.4.1 Setup the EUT as shown in Section 10 .1.

12.4.2. Turn on the power of all equipments.

12.4.3. Let the EUT work in test mode (Normal) and measure it.

## 12.5 Test Procedure

- 1) Set up the EUT and test generator as shown on Section 10.1.2.
- 2) For DC port coupling mode, provide a 1 KV 1.2/50us voltage surge (at open-circuit condition) and 8/20us current surge to EUT selected points.
- 3) At least 5 positive and 5 negative (polarity) tests with a maximum 1/min repetition rate are conducted during test.
- 4) Record the EUT operating situation during compliance test and decide the EUT immunity criterion for above each test.

## 12.6 Test Result

PASS

Temperature ( °C )	22~23
Humidity ( %RH )	50~54
Barometric Pressure ( mbar )	950~1000
EUT	2 Wheel Auto - Balancing Electric Scooter
M/N	Y1 (TIRE 6.5 INCH)
Operating Mode	Normal

Level	Voltage	Poll	Path	Pass	Fail
1	0.5kV	±	L-N, L-PE, N-PE	/	/
2	1kV	±	L-N	A	/
3	2kV	±	L-PE, N-PE	/	/
4	4kV	±	L-N, L-PE, N-PE	/	/

### 13. CONDUCTED SUSCEPTIBILITY TEST (EN 61000-4-6)

#### 13.1 Block Diagram of Test Setup

##### 13.1.1. Block Diagram of the EUT

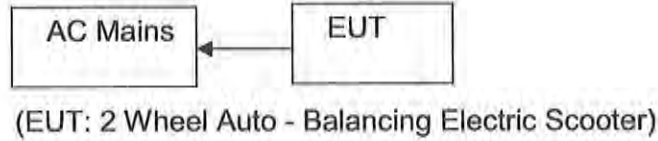

##### 13.1.2. Block Diagram of the AC Mains

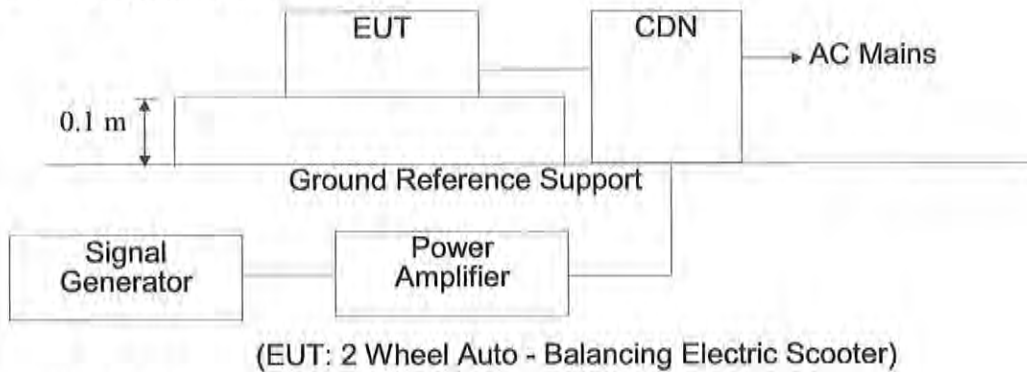

#### 13.2 Test Standard

EN 55014-2: 1997+A1:2001+A2:2008 (EN61000-4-6: 2009, Severity Level 2: 3V(rms)).  
(0.15MHz ~ 230MHz)

#### 13.3 Severity Levels and Performance Criterion

##### 13.3.1. Severity level

Level	Field Strength V(r.m.s)
1	1
2	3
3	10
X	Special

##### 13.3.2 Performance criterion: A

#### 13.4 Operating Condition of EUT

13.4.1 Setup the EUT as shown in Section 11 .1.

13.4.2 Turn on the power of all equipments.

13.4.3 Let the EUT work in test mode (Normal) and measure it.

### 13.5 Test Procedure

#### 13.5.1 For AC Mains

It's unnecessary to test.

#### 13.5.2 For signal lines and control lines ports:

It's unnecessary to test.

#### 13.5.3 For DC Input line ports:

- 1) Set up the EUT, CDN and test generators as shown on Section 11 .1.
- 2) Let the EUT work in test mode and measure it.
- 3) The EUT are placed on an insulating support 0.1m high above a ground reference plane. CDN (coupling and decoupling network) is placed on the ground plane about 0.3m from EUT. Cables between CDN and EUT are as short as possible, and their height above the ground reference plane shall be between 30 and 50 mm (where possible).
- 4) The disturbance signal described below is injected to EUT through CDN.
- 5) The EUT operates within its operational mode(s) under intended climatic conditions after power on.
- 6) The frequency range is swept from 150KHz to 230MHz using 3V signal level, and with the disturbance signal 80% amplitude modulated with a 1KHz sine wave.
- 7) The rate of sweep shall not exceed  $1.5 \times 10^{-3}$  decades/s. Where the frequency is swept incrementally, the step size shall not exceed 1% of the start and thereafter 1% of the preceding frequency value.

Recording the EUT operating situation during compliance testing and decide the EUT immunity criterion.

### 13.6 Test Results

PASS

**Frequency Range (MHz):** 0.15~230MHz  
**Modulation:** Amplitude 80%, 1 kHz sinewave  
**Severity Level:** 3Vr.m.s.

Temperature ( °C )	22~23
Humidity ( %RH )	50~54
Barometric Pressure ( mbar )	950~1000
EUT	2 Wheel Auto - Balancing Electric Scooter
M/N	Y1 (TIRE 6.5 INCH)
Operating Mode	Normal

Level	Voltage Level (e.m.f.) U <sub>0</sub>	Pass	Fail
1	1	/	/
2	3	A	/
3	10	/	/
X	Special	/	/



## 14. VOLTAGE DIPS, SHORT INTERRUPTIONS IMMUNITY TESTS (EN61000-4-11)

### 14.1 Block Diagram of Test Setup

#### 14.1.1. Block Diagram of the EUT



(EUT: 2 Wheel Auto - Balancing Electric Scooter)

#### 14.1.2. Block Diagram of the AC Mains

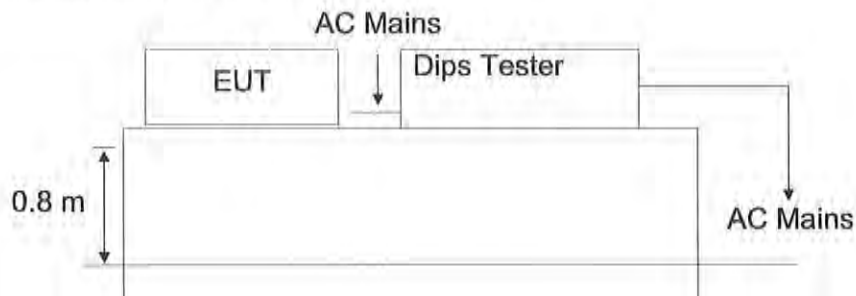

(EUT: 2 Wheel Auto - Balancing Electric Scooter)

### 14.2 Test Standard

EN 55014-2:1997+A1:2001+A2:2008 (EN61000-4-11: 2004)

### 14.3 Severity Levels and Performance Criterion

Test Level %UT	Voltage dip and short interruptions %UT	Duration (in period)
0	100	0.5 1 5
40	60	10 25
70	30	50 *

Performance criterion: B&C

### 14.4 EUT Configuration

The configuration of EUT is listed in Section 12 .4.

### 14.5 Operating Condition of EUT

14.5.1 Turn on the power of all equipments.

14.5.2 Let the EUT work in test mode (Normal) and measure it.

## 14.6 Test Procedure

- 1) Set up the EUT and test generator as shown on Section 12.1.2.
- 2) The interruption is introduced at selected phase angles with specified duration.
- 3) Record any degradation of performance.

## 14.7 Test Result

PASS

Temperature ( °C )	22~23
Humidity ( %RH )	50~54
Barometric Pressure ( mbar )	950~1000
EUT	2 Wheel Auto - Balancing Electric Scooter
M/N	Y1 (TIRE 6.5 INCH)
Operating Mode	Normal

Level	U2	Td(periods)	Phase Angle	N	Pass	Fail
1	100%	0.5	0/90/180/270	3	B	/
2	30%	10	0/90/180/270	3	C	/
3	60%	50	0/90/180/270	3	C	/

Note:

- A. The apparatus shall continue to operate as intended during and after the test. The manufacturer specifies some minimum performance level. The performance level may be specified by the manufacturer as a permissible loss of performance.
- B. The apparatus shall continue to operate as intended after the test. This indicates that the EUT does not need to function at normal performance levels during the test, but must recover. Again some minimal performance is defined by the manufacture. No change in operating state or loss of data is permitted.
- C. Temporary loss of function is allowed. Operation of the EUT may stop as long as it is either automatically reset or can be manually restored by operation of the controls.

## 15. TEST RESULTS

---

The following tests were performed on the Yue Mao (ASIA) Ltd.'s product; model: Y1 (TIRE 6.5 INCH); the actual test results are contained within the Test Data section of this report.

### 15.1 EN 61000-4-2 Electrostatic Discharge Immunity Test Configuration

The EUT was subjected to the electrostatic discharge tests required by EN 55014-2 and all lower levels specified in EN 61000-4-2.

*The EUT continued to perform as intended during and after the application of the ESD. Test setup pNormalographs presented in Appendix C.*

### 15.2 EN 61000-4-3 Electrostatic Discharge Immunity Test Configuration

The EUT was subjected to the electrostatic discharge tests required by EN 55014-2 and all lower levels specified in EN 61000-4-3.

*The EUT continued to perform as intended during and after the application of the ESD. Test setup pNormalographs presented in Appendix C.*

### 15.3 EN 61000-4-4 Electrical Fast Transient/Burst Immunity Test Configuration

The EUT was subjected to the electrical fast transient tests required by EN 55014-2 and all lower levels specified in EN 61000-4-4.

*The EUT continued to perform as intended during and after the application of the EFT/B. Test setup pNormalographs presented in Appendix C.*

### 15.4 EN 61000-4-5 Surge Immunity Test Configuration

The EUT was subjected to the Surge Immunity tests required by EN 55014-2 and all lower levels specified in EN 61000-4-5.

*The EUT continued to perform as intended during and after the application of the Surge Immunity Test.*

### 15.5 EN 61000-4-6 Conducted Susceptibility Test Configuration

The EUT was subjected to the Conducted Susceptibility tests required by EN 55014-2 and all lower levels specified in EN 61000-4-6.

*The EUT continued to perform as intended during and after the application of the Conducted Susceptibility Test.*

### 15.6 EN 61000-4-11 Voltage Dips, Short Interruptions Immunity Tests Configuration

The EUT was subjected to the Voltage Dips/Interruptions tests required by EN 55014-2 and all lower levels specified in EN 61000-4-11.

*The EUT continued to perform as intended during and after the application of the Voltage Dips/Interruptions Test.*

## Appendix A - Product Labeling

---

### CE Mark Label Specification

Specification: Text is Black or white in color and is left justified. Labels are printed in indelible ink on permanent adhesive backing and shall be affixed at a conspicuous location on the EUT or Silk-screened onto the EUT.



## Appendix B - EUT PHOTOGRAPHS

---

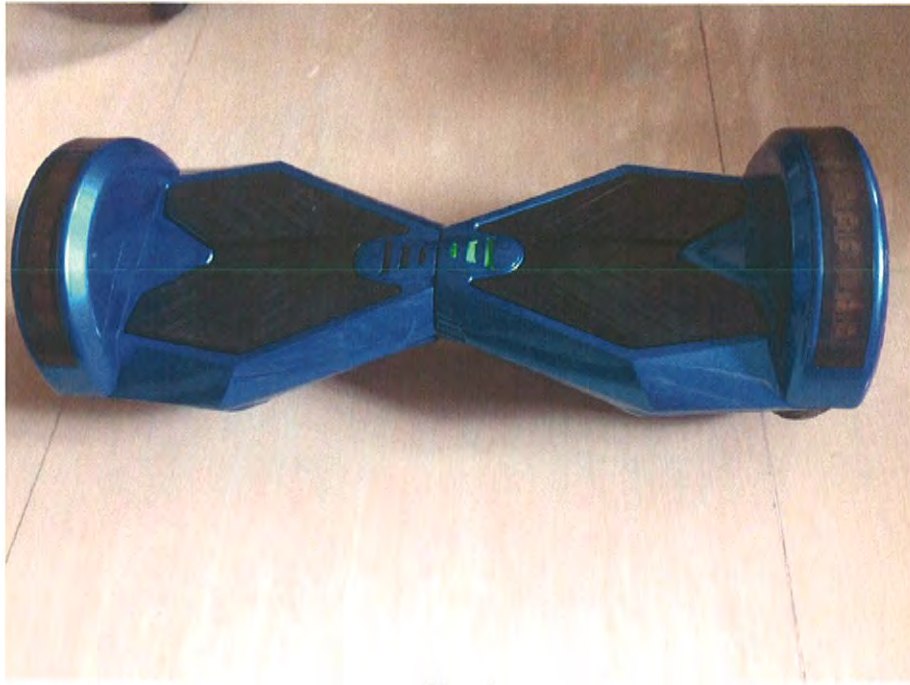

Fig. 1



Fig. 2

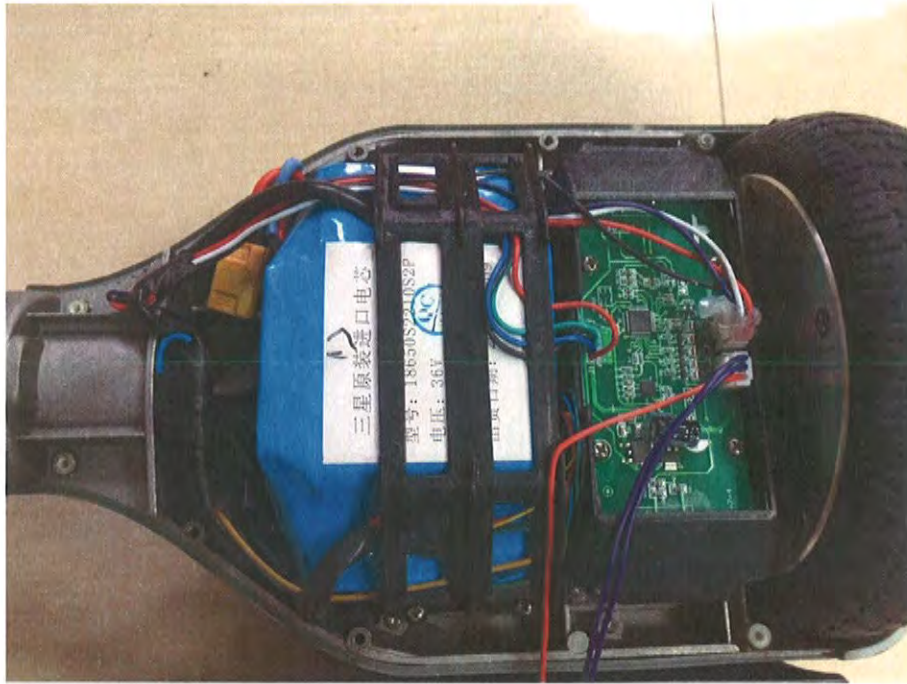

Fig. 3

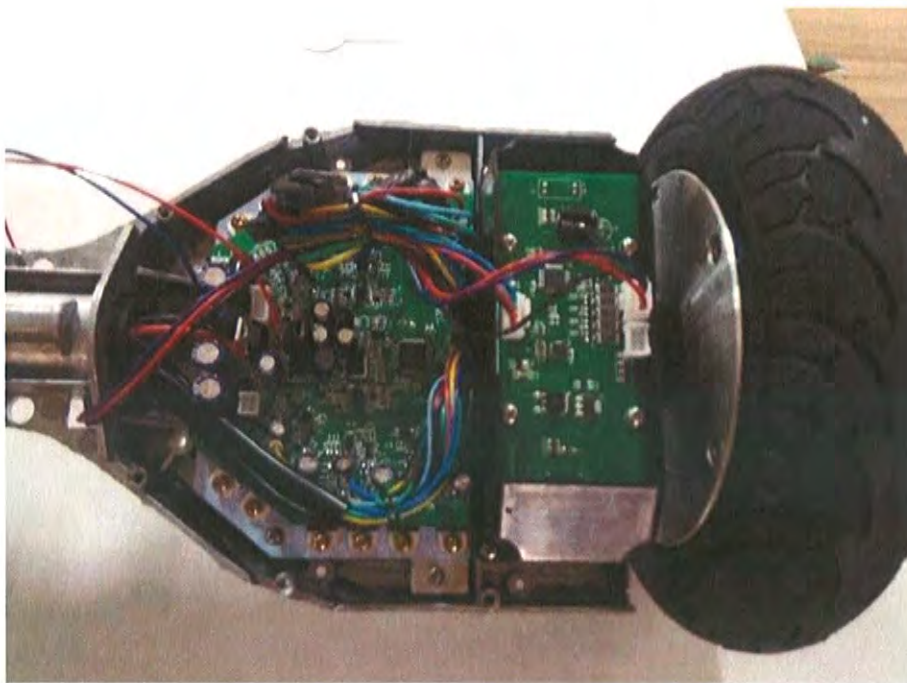

Fig. 4

\*\*\*\*\*END OF THE REPORT\*\*\*\*\*

## APPLICATION FOR GEMS TEST REPORT

On Behalf of

Product Name : AC/DC Charger  
Model : XVE-4200200

Prepared By : SHENZHEN POCE TECHNOLOGY CO., LTD.

H Building, Hongfa Science And Technology Park, Tangtou, Shiyan,  
Bao'An District, Shenzhen, China



Test Date : Sep. 12, 2015- Sep. 17, 2015

Date of Report : Sep. 17, 2015

Report No. : POCE15091204ZRS

**TEST REPORT**

Australian and New Zealand Energy Performance Requirements External Power supplies Minimum Energy Performance Standards (MEPS)  
 AS/NZS 4665.1: 2005+A1:2009  
 AS/NZS 4665.2: 2005+A1:2009

Reference No. .... : POCE15091204ZRS

Compiled by (+ signature) ..... : Calvin Chen/ Project Engineer

*Calvin Chen*

Approved by (+ signature) ..... : Bophe Mo / Manager

*Bophe Mo*

Date of issue ..... : Sep. 17, 2015

Contents ..... : 5 pages including the cover page

**Testing laboratory**

Name ..... : SHENZHEN POCE TECHNOLOGY CO., LTD

Address ..... : H Building, Hongfa Science And Technology Park, Tangtou, Shiyuan, Bao'an District, Shenzhen, China

Testing location ..... : Same as above



**Test specification**

Standard ..... : AS/NZS 4665.2:2005 + A1:2009  
 AS/NZS 4665.1:2005 + A1:2009

Test procedure ..... : MEPS

Procedure deviation ..... : N.A.

Non-standard test method ..... : N.A.

**Test item**

Description ..... : AC/DC Charger

Trademark ..... : N/A

Model and/or type reference ..... : XVE-4200200

Rating(s) ..... : Input: 100-240V~ 50/60Hz, 2.5A  
 Output: 42V --- 2A



**EQUIPMENT FOR TEST:**

Equipment Name	Manufacturers	Measurement	Calibration Date
Power Meter	YOKOGAWA	WT210	2015-03-25
Electronic Load	PRODIGIT	3302C	2015-03-25
Measuring Tape	Hongda	71MM	2015-03-25
Temperature-Humidity Recorder	Houjie	TH	2015-12-02

**Test conditions**

Supply voltage is provided by the following equipment, and THD of the supply voltage is 0.3%, up to and including the 13th harmonic.

Equipment name: Harmonics/Flicker Test Analyzer

Manufacturer: Voltech

Model No.: PM6000

Serial No.: 200006700495

Date of Calibration: 2015.02.01

Summary of test results	Table A1 (Mark V) required	Measured
Minimum average efficiency in active mode	77.75%	115V: 79.66%
		230V: 80.95%
Maximum energy consumption in no-load mode	0.5W	115V: 0.35W
		230V: 0.45W

**Conclusion** **PASS**  
 Efficiency Level .....: V (Detailed data see below report)

Copy of Marking plate:

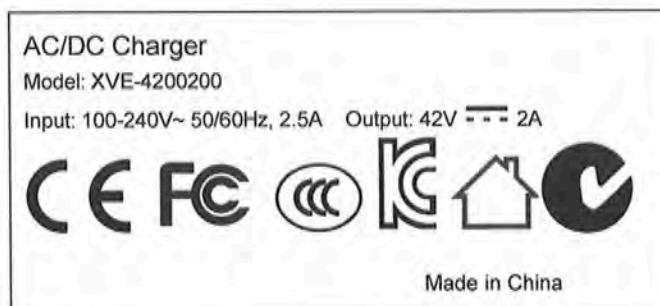

Measure and Calculated Date at 115V 60Hz for XVE-4200200						
V Active $\geq 77.75\%$		No load $\leq 0.5W$				
	No Load	Active Power Values				
Percent of Nameplate Current	0%	25%	50%	75%	100%	Average
Dc Output Current (mA)	-	500	1000	1500	2000	-
Dc Output Voltage (V)	-	42.26	41.75	41.24	40.26	-
Dc Output Power (W)	-	21.04	41.75	61.77	80.52	-
Ac Input Voltage (V)	115	115	115	115	115	-
Ac Input Power (W)	0,335	27.1	52.1	78.2	96.2	-
True Power Factor	--	0.542	0.564	0.582	0.597	0,571
Ac Input Frequency (Hz)	60	60	60	60	60	-
Power Consumed by UUT (W)	0,35	5,7	10,35	16,43	15,68	-
Efficiency		78.97%	80.01%	78.98%	83,70%	79.66%

Measure and Calculated Date at 230V 50Hz for XVE-4200200						
V Active $\geq 77.75\%$		No load $\leq 0.5W$				
	No Load	Active Power Values				
Percent of Nameplate Current	0%	25%	50%	75%	100%	Average
Dc Output Current (mA)		500	1000	1500	2000	-
Dc Output Voltage (V)		41.94	41.46	41.19	41.05	-
Dc Output Power (W)		20.88	41.46	61.72	82.10	-
Ac Input Voltage (V)	230	230	230	230	230	-
Ac Input Power (W)	0.45	27.8	51.5	75.3	95.2	-
True Power Factor	--	0.566	0.593	0.599	0.600	0.589
Ac Input Frequency (Hz)	50	50	50	50	50	-
Power Consumed by UUT (W)	0.45	0.69	10.4	13.58	1.31	-
Efficiency		75.11%	80.5%	81.96%	86.23%	80.95%

**ATTACHMENT: PHOTOS OF EUT**



Photo 1 front view



Photo 2 rear view

**\*\*\* The end of report \*\*\***

## APPLICATION FOR GEMS TEST REPORT

On Behalf of

Product Name : AC/DC Charger  
Model : XVE-4200200

Prepared By : SHENZHEN POCE TECHNOLOGY CO., LTD.  
H Building, Hongfa Science And Technology Park, Tangtou, Shiyao,  
Bao'An District, Shenzhen, China



Test Date : Sep. 12, 2015- Sep. 17, 2015  
Date of Report : Sep. 17, 2015  
Report No. : POCE15091203RRS

**TEST REPORT**

IEC 60335-1

Household and similar electrical appliances - Safety - Part 1: General requirements

IEC 60335-2-29

Household and similar electrical appliances - Safety - Part 2-29: Particular requirements for battery chargers

Reference No. .... : POCE15091203RRS

Compiled by (+ signature)..... : Calvin Chen/ Project Engineer

*Calvin Chen*

Approved by (+ signature)..... : Bophe Mo / Manager

*Bophe Mo*

Date of issue ..... : Sep. 17, 2015

Contents ..... : 55 pages including the cover page

**Testing laboratory**

Name ..... : SHENZHEN POCE TECHNOLOGY CO., LTD.

Address ..... : H Building, Hongfa Science And Technology Park, Tangtou, Shiyan, Bao'An District, Shenzhen, China

Testing location ..... : Same as above

**Client**

Name ..... :

Address ..... :

**Test specification**

Standard ..... : IEC 60335-2-29: 2010 &amp; IEC 60335-1:2013+AC: 2014

Test procedure ..... : IEC

Procedure deviation ..... : N.A.

Non-standard test method ..... : N.A.

**Test item**

Description ..... : AC/DC Charger

Trademark ..... : N/A

Model and/or type reference ..... : XVE-4200200

Manufacturer ..... :

Address ..... :

Rating(s) ..... : Input: 100-240V~ 50/60Hz, 2.5A

Output: 42V --- 2A



**AC/DC Charger**

Model: XVE-4200200

Input: 100-240V~ 50/60Hz, 2.5A Output: 42V  2A



Made in China

IEC 60335-2-29			
Clause	Requirement - Test	Result - Remark	Verdict
5	GENERAL CONDITIONS FOR THE TESTS		P
	Tests performed according to cl. 5, e.g. nature of supply, sequence of testing, etc.		P
5.2	If the test of 21.101 is carried out two additional battery chargers are required (IEC 60335-2-29)	See clause 21.101.	P
5.101	Battery chargers are tested as motor-operated appliances (IEC 60335-2-29)	Tested as motor-operated appliances.	P
6	CLASSIFICATION		P
6.1	Protection against electric shock: Class 0, 0I, I, II, III .....	Class I appliance.	P
6.2	Protection against harmful ingress of water	IP20.	N/A
7	MARKING AND INSTRUCTIONS		P
7.1	Rated voltage or voltage range (V).....	AC 100-240V	P
	Nature of supply .....	Frequency provided, see below	P
	Rated frequency (Hz).....	50/60Hz	P
	Rated power input (W) .....	Not shown.	N/A
	Rated current (A) .....	See page 2.	P
	Manufacturer's or responsible vendor's name, trademark or identification mark .....		P
	Model or type reference .....	XVE-4200200	P
	Symbol 5172 of IEC 60417, for Class II appliances	Class I appliance.	N/A
	IP number, other than IPX0 .....		N/A
	Symbol IEC 60417-5036, for the enclosure of electrically-operated water valves in external hose-sets for connection of an appliance to the water mains		N/A
	Battery chargers marked with (IEC 60335-2-29):		P
	- rated d.c. output voltage (V)	See page 2.	P
	- rated d.c. output current (A)	See page 2.	P
	- rated current (A) of protective devices incorporated in a d.c. distribution board	No d.c. distribution boards.	N/A
	- polarity of the output terminals	On the enclosure.	P
	Relation between marking for upper and lower limits of rated power input or rated current and voltage is clear		N/A
7.6	Correct symbols used		P
7.7	Connection diagram fixed to appliances to be connected to more than two supply conductors and appliances for multiple supply		N/A
7.8	Except for type Z attachment, terminals for connection to the supply mains indicated as follows:		N/A
	- marking of terminals exclusively for the neutral conductor (N)	Appliance inlet provided.	N/A



IEC 60335-2-29			
Clause	Requirement - Test	Result - Remark	Verdict
	- marking of protective earthing terminals (symbol 5019 of IEC 60417)		N/A
	- marking not placed on removable parts		N/A
7.9	Marking or placing of switches which may cause a hazard		P
7.10	Indications of switches on stationary appliances and controls on all appliances by use of figures, letters or other visual means .....	See below.	P
	The figure 0 indicates only OFF position, unless no confusion with the OFF position	Switch marking with O and I.	P
7.11	Indication for direction of adjustment of controls	No adjustment of controls.	N/A
7.12	Instructions for safe use provided		P
	Instructions for safe use contains (IEC 60335-2-29):		P
	- specification of types, number of cells and rated capacity of batteries that can be charged		P
	- warning against recharging non-rechargeable batteries	Provided.	P
	- statement that during charging, batteries must be placed in the well ventilated area, only for battery chargers for lead-acid batteries		P
	- statement that battery chargers must only be plugged into an earthed socket-outlet, only for portable Class I battery chargers for outdoor use	Class I battery charger and indoor use only.	N/A
	- explanation of automatic function stating any limitation, only for automatic battery chargers		N/A
	Battery chargers for charging automobile batteries include substance concerning (IEC 60335-2-29):		N/A
	- way of connection of battery terminal to chassis		N/A
	- way of disconnection of battery charger and chassis connection		N/A
7.12.1	Sufficient details for installation supplied		P
7.7	Connection diagram fixed to appliances to be connected to more than two supply conductors and appliances for multiple supply		N/A
7.8	Except for type Z attachment, terminals for connection to the supply mains indicated as follows:		N/A
	- marking of terminals exclusively for the neutral conductor (N)	Appliance inlet provided.	N/A
	- marking of protective earthing terminals (symbol 5019 of IEC 60417)		N/A
	- marking not placed on removable parts		N/A
7.9	Marking or placing of switches which may cause a hazard		P
7.10	Indications of switches on stationary appliances and controls on all appliances by use of figures, letters or other visual means .....	See below.	P
	The figure 0 indicates only OFF position, unless no	Switch marking with O and I.	P

IEC 60335-2-29			
Clause	Requirement - Test	Result - Remark	Verdict
	confusion with the OFF position		
7.11	Indication for direction of adjustment of controls	No adjustment of controls.	N/A
7.12	Instructions for safe use provided		P
	Instructions for safe use contains (IEC 60335-2-29):		P
	- specification of types, number of cells and rated capacity of batteries that can be charged		P
	- warning against recharging non-rechargeable batteries	Provided.	P
	- statement that during charging, batteries must be placed in the well ventilated area, only for battery chargers for lead-acid batteries		P
	- statement that battery chargers must only be plugged into an earthed socket-outlet, only for portable Class I battery chargers for outdoor use	Class I battery charger and indoor use only.	N/A
	- explanation of automatic function stating any limitation, only for automatic battery chargers		N/A
	Battery chargers for charging automobile batteries include substance concerning (IEC 60335-2-29):		N/A
	- way of connection of battery terminal to chassis		N/A
	- way of disconnection of battery charger and chassis connection		N/A
7.12.1	Sufficient details for installation supplied		P
	Instructions concerning new and old hose-sets for appliances connected to the water mains by detachable hose-sets		N/A
7.13	Instructions and other texts in an official language	English languages.	P
7.14	Marking clearly legible and durable		P
7.15	Marking on a main part	On the enclosure.	P
	Marking clearly discernible from the outside, if necessary after removal of a cover	No removal covers.	P
	For portable appliances, cover can be removed or opened without a tool		N/A
	For stationary appliances, name, trademark or identification mark and model or type reference visible after installation		N/A
	For fixed appliances, name, trademark or identification mark and model or type reference visible after installation according to the instructions	Compliance checked.	P
	Indications for switches and controls placed on or near the components. Marking not on parts which can be positioned or repositioned in such a way that the marking is misleading	No switches or controls.	N/A
7.16	Marking of a possible replaceable thermal link or fuse link clearly visible with regard to replacing the link	FS1: F10A/250V, output fuse marked on the fuse body.	P
7.101	D.C. distribution boards marked with (IEC 60335-2-29):		N/A
	- maximum output current (A) for each output circuit.:	No D.C. distribution boards.	N/A

IEC 60335-2-29			
Clause	Requirement - Test	Result - Remark	Verdict
	- types of any additional power supply which can be connected		N/A
8	PROTECTION AGAINST ACCESS TO LIVE PARTS		P
8.1	Adequate protection against accidental contact with live parts	Building-in battery charger must be investigated in the final system assembly.	N/A
8.1.1	Requirement applies for all positions, detachable parts removed		N/A
	Insertion or removal of lamps, protection against contact with live parts of the lamp cap		N/A
	Use of test probe B of IEC 61032: no contact with live parts		N/A
8.1.2	Use of test probe 13 of IEC 61032 through openings in class 0 appliances and class II		N/A
	Test probe 13 also applied through openings in earthed metal enclosures having a non-conductive		N/A
8.1.3	For appliances other than class II, use of test probe 41 of IEC 61032: no contact with live parts of visible		N/A
8.1.4	Accessible part not considered live if:		P
	- safety extra-low a.c. voltage: peak value not exceeding 42,4 V		N/A
	- safety extra-low d.c. voltage: not exceeding 42,4 V		P
	- or separated from live parts by protective impedance	Two Y1 type capacitors (C31 and C32) provided between primary and secondary circuits.	P
	If protective impedance: d.c. current not exceeding 2 mA, and	See below.	P
	a.c. peak value not exceeding 0,7 mA	- Normal condition: 0.29mA, - C30 or C31 shorted condition: 0.58mA.	P
	- for peak values over 42,4 V up to and including 450 V, capacitance not exceeding 0,1 $\mu$ F		N/A
	- for peak values over 450 V up to and including 15 kV, discharge not exceeding 45 $\mu$ C		N/A
8.1.5	Live parts protected at least by basic insulation before installation or assembly:		P
	- built-in appliances		P
	- fixed appliances		N/A
	- appliances delivered in separate units		N/A

IEC 60335-2-29			
Clause	Requirement - Test	Result - Remark	Verdict
8.2	Class II appliances and constructions constructed so that there is adequate protection against accidental contact with basic insulation and metal parts separated from live parts by basic insulation only		P
	Only possible to touch parts separated from live parts by double or reinforced insulation	Output terminals separated by double or reinforced insulation from primary circuits.	P
9	STARTING OF MOTOR-OPERATED APPLIANCES		N/A
	Requirements and tests are specified in part 2 when necessary		N/A
10	POWER INPUT AND CURRENT		P
10.1	Power input at normal operating temperature, rated voltage and normal operation not deviating from rated power input by more than shown in table 1		N/A
10.2	Current at normal operating temperature, rated voltage and normal operation not deviating from rated current by more than shown in table 2	(See appended table)	P
10.101	No-load d.c. output voltage does not exceed 42,2 V (IEC 60335-2-29).....:	Max. 28.8V(PB-300Y-24) < 42.4V	P
10.102	Arithmetic mean value of output current does not deviate from rated d.c. output current by more than 10 % (IEC 60335-2-29)	(See appended table)	P
11	HEATING		P
11.1	No excessive temperatures in normal use		P
11.2	Placing and mounting of battery chargers in the test corner as specified for heating appliances (IEC 60335-2-29)		P
11.3	Temperature rises, other than of windings, determined by thermocouples	By thermocouples.	P
	Temperature rises of windings determined by resistance method, unless		N/A
	the windings makes it difficult to make the necessary connections		N/A
11.4	Heating appliances operated under normal operation at 1,15 times rated power input .....	See below.	N/A
11.5	Battery chargers supplied only at 1,06 times rated voltage (IEC 60335-2-29).....:	At 90V and 255V.	P
11.6	Combined appliances operated under normal operation at most unfavourable voltage between 0.94 and 1,06 times rated voltage .....		N/A
11.7	Battery chargers operate until steady conditions are established (IEC 60335-2-29)		P
11.8	Temperature rises not exceeding values in table 3	(See appended tables)	P

IEC 60335-2-29			
Clause	Requirement - Test	Result - Remark	Verdict
	Sealing compound does not flow out		N/A
	Protective devices do not operate, except		P
	components in protective electronic circuits tested for the number of cycles specified in 24.1.4		N/A
13	LEAKAGE CURRENT AND ELECTRIC STRENGTH AT OPERATING TEMPERATURE		P
13.1	Leakage current not excessive and electric strength adequate		P
	Heating appliances operated at 1,15 times rated power input .....		N/A
	Motor-operated appliances and combined appliances supplied at 1,06 times rated voltage .....	At 255V.	P
	Protective impedance and radio interference filters disconnected before carrying out the tests		P
13.2	Leakage current measured by means of the circuit described in figure 4 of IEC 60990	Used figure 4 of IEC 60990.	P
	Leakage current measurements	(See appended table)	P
13.3	The appliance is disconnected from the supply		P
	Electric strength tests according to table 4	(See appended table)	P
	No breakdown during the tests	No breakdown.	P
14	TRANSIENT OVERVOLTAGES		N/A
	Appliances withstand the transient overvoltages to which they may be subjected		N/A
	Clearances having a value less than specified in table 16 subjected to an impulse voltage test, the test voltage specified in table 6		N/A
	No flashover during the test, unless of functional insulation		N/A
	In case of flashover of functional insulation, the appliance complies with clause 19 with the clearance short circuited		N/A
15	MOISTURE RESISTANCE		P
15.1	Enclosure provides the degree of moisture protection according to classification of the appliance	IP20 for indoor use.	N/A
	Compliance checked as specified in 15.1.1, taking into account 15.1.2, followed by the electric strength test of 16.3		N/A

IEC 60335-2-29			
Clause	Requirement - Test	Result - Remark	Verdict
	No trace of water on insulation which can result in a reduction of clearances and creepage distances below values specified in clause 29		N/A
15.1.1	Appliances, other than IPX0, subjected to tests as specified in IEC 60529 .....	IP20.	N/A
	Water valves in external hoses for connection of an appliance to the water mains tested as specified for IPX7 appliances		N/A
15.1.2	Hand-held appliance turned continuously through the most unfavourable positions during the test		N/A
	Built-in appliances installed according to the instructions		N/A
	Appliances placed or used on the floor or table placed on a horizontal unperforated support		N/A
	Appliances normally fixed to a wall and appliances with pins for insertion into socket-outlets are mounted on a wooden board		N/A
	For IPX3 appliances, the base of wall mounted appliances is placed at the same level as the pivot axis of the oscillating tube		N/A
	For IPX4 appliances, the horizontal centre line of the appliance is aligned with the pivot axis of the oscillating tube		N/A
	However, for appliances normally used on the floor or table, the movement is limited to two times 90 for a period of 5 min, the support being placed at the level		N/A
	Appliances normally fixed to a ceiling are mounted underneath a horizontal unperforated support, the pivot axis of the oscillating tube located at the level of		N/A
	For IPX4 appliances, the movement of the tube is limited to two times 90 from the vertical for a period of 5 min		N/A
	Wall-mounted appliances, take into account the distance to the floor stated in the instructions		N/A
	Appliances with type X attachment fitted with a flexible cord as described		N/A
	Detachable parts tested as specified		N/A
15.2	Spillage of liquid does not affect the electrical insulation	No liquid containers.	N/A

IEC 60335-2-29			
Clause	Requirement - Test	Result - Remark	Verdict
	Appliances with type X attachment fitted with a flexible cord as described		N/A
	Appliances incorporating an appliance inlet tested with or without an connector, whichever is most unfavourable		N/A
	Detachable parts removed		N/A
	Overfilling test with additional amount of water, over a period of 1 min (l) .....		N/A
	The appliance withstands the electric strength test of 16.3		N/A
	No trace of water on insulation that can result in a reduction of clearances and creepage distances below values specified in clause 29		N/A
15.3	Appliances proof against humid conditions		N/A
	Humidity test for 48 h in a humidity cabinet	At 25°C, 95%R.H.	P
	The appliance withstands the tests of clause 16		P
16	LEAKAGE CURRENT AND ELECTRIC STRENGTH		P
16.1	Leakage current not excessive and electric strength adequate		P
	Protective impedance disconnected from live parts before carrying out the tests		P
16.2	Single-phase appliances: test voltage 1,06 times rated voltage .....	At 255V.	P
	Three-phase appliances: test voltage 1,06 times rated voltage divided by $\sqrt{3}$ .....	Single-phase appliances.	N/A
	Leakage current measurements	(See appended table)	P
16.3	Electric strength tests according to table 7	(See appended table)	P
	No breakdown during the tests	No breakdown.	P
17	OVERLOAD PROTECTION OF TRANSFORMERS AND ASSOCIATED CIRCUITS		P
	No excessive temperatures in transformer or associated circuits in event of short-circuits likely to occur in normal use	(See appended table)	P
	Appliance supplied with 1,06 or 0,94 times rated voltage and the most unfavourable short-circuit or overload likely to occur in normal use applied.....	Transformer secondary shorted test at 255V.	P
	Output terminals of battery chargers are short-circuited (IEC 60335-2-29)	Unit shut down.	P
	Temperature rise of insulation of the conductors of safety extra-low voltage circuits not exceeding the relevant value specified in table 3 by more than 15 K		N/A

IEC 60335-2-29			
Clause	Requirement - Test	Result - Remark	Verdict
	Temperature of the winding not exceeding the value specified in table 8,		P
	however limits do not apply to fail-safe transformers complying with sub-clause 15.5 of IEC 61558-1		P
18	ENDURANCE		N/A
	Requirements and tests are specified in part 2 when necessary		N/A
19	ABNORMAL OPERATION		P
19.1	The risk of fire or mechanical damage under abnormal or careless operation obviated		P
	Electronic circuits so designed and applied that a fault will not render the appliance unsafe	See 19.11 and 19.12.	P
	Battery chargers subjected to the tests of 19.11, 19.12 and 19.101 to 19.103 (IEC 60335-2-29)		P
19.2	Test of appliance with heating elements with restricted heat dissipation; test voltage (V): power input of 0,85 times rated power input .....	No heating elements.	N/A
19.3	Test of 19.2 repeated; test voltage (V): power input of 1,24 times rated power input .....		N/A
19.4	Test conditions as in cl. 11, any control limiting the temperature during tests of cl. 11 short-circuited		N/A
19.5	Test of 19.4 repeated on Class 0I and I appliances with tubular sheathed or embedded heating elements. No short-circuiting, but one end of the element connected to the elements sheath		N/A
	The test repeated with reversed polarity and the other end of the heating element connected to the sheath		N/A
	The test is not carried out on appliances intended to be permanently connected to fixed wiring and on appliances where an all-pole disconnection occurs during the test of 19.4		N/A
19.6	Appliances with PTC heating elements tested at rated voltage, establishing steady conditions		N/A
	The working voltage of the PTC heating element is increased by 5% and the appliance is operated		N/A
19.7	Stalling test by locking the rotor if the locked rotor torque is smaller than the full load torque or	No motors.	N/A
	Locked rotor, motor capacitors open-circuited or short-circuited, if required		N/A
	Locked rotor, capacitors open-circuited one at a time		N/A



IEC 60335-2-29			
Clause	Requirement - Test	Result - Remark	Verdict
	Test repeated with capacitors short-circuited one at a time, if required		N/A
	Appliances with timer or programmer supplied with rated voltage for each of the tests, for a		N/A
	Other appliances supplied with rated voltage for a period as specified		N/A
	Winding temperatures not exceeding values specified in table 8		N/A
19.8	Three-phase motors operated at rated voltage with one phase disconnected		N/A
19.9	Running overload test on appliances incorporating motors intended to be remotely or automatically		N/A
	Winding temperatures not exceeding values as specified		N/A
19.10	Series motor operated at 1,3 times rated voltage for		N/A
	During the test, parts not being ejected from the appliance		N/A
19.11	Electronic circuits, compliance checked by evaluation of the fault conditions specified in	See 19.11.2.	P
	Appliances incorporating a protective electronic circuit subjected to the tests of 19.11.3 and	See 19.11.3.	P
	Appliances having a switch with an off position obtained by electronic disconnection, or a switch		N/A
19.11.1	Before applying the fault conditions a) to f) in 19.11.2, it is checked if circuits or parts of circuit meet both of the following conditions:		N/A
	- the electronic circuit is a low-power circuit, that is, the maximum power at low-power points does not exceed 15 W according to the tests specified		N/A
	- the protection against electric shock, fire hazard, mechanical hazard or dangerous malfunction in other parts of the appliance does not rely on the correct functioning of the electronic circuit		N/A
19.11.2	Fault conditions applied one at a time, the appliance operated under conditions specified in cl. 11, but supplied at rated voltage, the duration of the tests as specified:		P
	a) short circuit of functional insulation if clearances or creepage distances are less than the values specified in 29	See appended tables 29.1 and 29.2.	N/A
	b) open circuit at the terminals of any component	R12 and C48 opened, normal operation, no hazards.	P
	c) short circuit of capacitors, unless they comply with IEC 60384-14	C5, C301 shorted, no hazards.	P

IEC 60335-2-29			
Clause	Requirement - Test	Result - Remark	Verdict
	d) short circuit of any two terminals of an electronic component, other than integrated circuits. This fault condition is not applied between the two circuits of an optocoupler	Q110, U1, Q3 and SCR shorted, no hazards.	P
	e) failure of triacs in the diode mode	Q3 and SCR shorted, no hazards.	P
	f) failure of an integrated circuit	U1 shorted no hazards.	P
19.11.3	If the appliance incorporates a protective electronic circuit which operates to ensure compliance with clause 19, the relevant test is repeated with a single fault simulated, as indicated in a) to f) of 19.11.2	Component fault tests as clause 19.11.2 are repeated with a single fault simulated. No hazards.	P
	During and after each test the following is checked:		P
	- the temperature rise of the windings do not exceed the values specified in table 8		P
	- the appliance complies with the conditions specified in 19.13		P
	- any current flowing through protective impedance not exceeding the limits specified in 8.1.4	See 8.1.4.	P
	If a conductor of a printed board becomes open-circuited, the appliance is considered to have withstood the particular test, provided all three of the following conditions are met:		N/A
	- the material of the printed circuit board withstands the burning test of annex E		N/A
	- any loosened conductor does not reduce the clearances or creepage distances between live		N/A
	- the appliance withstands the tests of 19.11.2 with open-circuited conductor bridged		N/A
19.11.4	Appliances having a switch with an off position obtained by electronic disconnection, or	No switches.	N/A
	a switch that can be placed in the stand-by mode,		N/A
	subjected to the tests of 19.11.4.1 to 19.11.4.7		N/A
	Appliances incorporating a protective electronic circuit subjected to the tests of 19.11.4.1 to		N/A
	appliances operated for 30 s or 5 min during the test of 19.7 are not subjected to the tests for		N/A
19.11.4.1	The appliance is subjected to electrostatic discharges in accordance with IEC 61000-4-2, test	Not apply for A1.	N/A
19.11.4.2	The appliance is subjected to radiated fields in accordance with IEC 61000-4-3, test level 3		N/A
19.11.4.3	The appliance is subjected to fast transient bursts in accordance with IEC 61000-4-4, test level 3 or 4 as		N/A

IEC 60335-2-29			
Clause	Requirement - Test	Result - Remark	Verdict
19.11.4.4	The power supply terminals of the appliance subjected to voltage surges in accordance with IEC		N/A
	Earthed heating elements in class I appliances disconnected		N/A
19.11.4.5	The appliance is subjected to injected currents in accordance with IEC 61000-4-6, test level 3		N/A
19.11.4.6	The appliance is subjected to voltage dips and interruptions in accordance with IEC 61000-4-11		N/A
19.11.4.7	The appliance is subjected to mains signals in accordance with IEC 61000-4-13, test level class 2		N/A
19.12	If the safety of the appliance for any of the fault conditions specified in 19.11.2 depends on the	Fuse current: 10A, measured	N/A
19.13	During the tests the appliance does not emit flames, molten metal, poisonous or ignitable gas in		P
	Temperature rises not exceeding the values shown in table 9	(See appended table)	P
	Winding temperatures not exceeding the values shown in table 8	(See appended table)	P
	Enclosures not deformed to such an extent that compliance with cl. 8 is impaired		P
	If the appliance can still be operated it complies with 20.2		P
	Insulation, other than of class III appliance, withstand the electric strength test of 16.3, the test voltage specified in table 4:		P
	- basic insulation.....:		N/A
	- supplementary insulation .....		N/A
	- reinforced insulation.....:	- Primary and secondary of transformer, - Primary and output.	P
	The appliance does not undergo a dangerous malfunction, and		P
	no failure of protective electronic circuits, if the appliance is still operable		P
	Appliances tested with an electronic switch in the off position or in the stand-by mode, do not become operational	No switches.	N/A
19.101	Battery chargers supplied at rated voltage and operated under normal operation, any control limiting the temperature during tests of clause 11 short-circuited (IEC 60335-2-29)	SHR 1 short, result: unit shut down, no hazards.	P
19.102	Reverse connection of battery chargers to a fully charged battery at rated voltage (IEC 60335-2-29)	Unit shut down.	P
	The capacity of the battery (IEC 60335-2-29).....:	125Ah.	P

IEC 60335-2-29			
Clause	Requirement - Test	Result - Remark	Verdict
19.103	Battery chargers intended to be used with a d.c. distribution board supplied at rated voltage and operated under normal operation, load increased as specified until protective device operates or short-circuit conditions are established (IEC 60335-2-29)	No d.c. distribution boards.	N/A
20.1	Adequate stability	Built-in & fixed appliance.	N/A
	Tilting test through an angle of 10° (appliance placed on an inclined plane/horizontal plane); appliance does not overturn		N/A
	Tilting test repeated on appliances with heating elements, angle of inclination increased to 15°	No heating elements.	N/A
	Possible heating test in overturned position; temperature rise does not exceed values shown in table 9		N/A
20.2	Moving parts adequately arranged or enclosed as to provide protection against personal injury	Building-in battery charger must be investigated in the final system assembly.	N/A
	Protective enclosures, guards and similar parts are non-detachable		N/A
	Adequate mechanical strength and fixing of protective enclosures		N/A
	Self-resetting thermal cut-outs and overcurrent protective devices not causing a hazard, by unexpected reclosure		N/A
	Not possible to touch dangerous moving parts with test probe		N/A
21	MECHANICAL STRENGTH		N/A
21.1	Appliance has adequate mechanical strength and is constructed as to withstand rough handling	Building-in battery charger must be investigated in the final system assembly.	N/A
	Checked by applying blows to the appliance in accordance with test of IEC 60068-2-75, spring hammer test, impact energy 1,0 J ± 0,05 J (IEC 60335-2-29)		N/A
	If necessary, supplementary or reinforced insulation subjected to the electric strength test of 16.3		N/A
	If necessary, repetition of groups of three blows on a new sample		N/A
21.2	Accessible parts of solid insulation having strength to prevent penetration by sharp implements	See below.	N/A
	The insulation is tested as specified, unless		N/A
	the thickness of supplementary insulation is at least 1 mm and reinforced insulation is at least 2 mm		N/A

IEC 60335-2-29			
Clause	Requirement - Test	Result - Remark	Verdict
21.101	Battery chargers, other than built-in battery chargers, having a mass not exceeding 5 kg, subjected to a drop test (IEC 60335-2-29)		N/A
	Battery chargers show no damage that could impair compliance with 8.1, 15.1.1, 16.3 and cl. 29 (IEC 60335-2-29)		N/A
21.102	Battery chargers for installing in caravans and similar vehicles withstand vibrations to which they may be subjected (IEC 60335-2-29)		N/A
	Vibration test as specified in IEC 60068-2-6 (IEC 60335-2-29)		N/A
	Battery chargers show no damage that could impair compliance with 8.1, 15.1.1, 16.3 and cl. 29 (IEC 60335-2-29)		N/A
	Connections have not worked loose (IEC 60335-2-29)		N/A
22	CONSTRUCTION		P
22.1	Appliance marked with the first numeral of the IP system, relevant requirements of IEC 60529 are fulfilled	IP20.	P
22.2	Stationary appliance: means to provide all-pole disconnection from the supply provided, the following means being available:		P
	- a supply cord fitted with a plug		N/A
	- a switch complying with 24.3		N/A
	- a statement in the instruction sheet that a disconnection incorporated in the fixed wiring is to be provided		N/A
	- an appliance inlet		P
	Single-pole switches and single-pole protective devices for the disconnection of heating elements in single-phase permanently connected class I appliances, connected in the phase conductor		N/A
22.3	Appliance provided with pins: no undue strain on socket-outlets	Appliance inlet provided.	N/A
	Applied torque not exceeding 0.25 Nm		N/A
	Pull force of 50N to each pin after the appliance has being placed in the heating cabinet; when cooled to room temperature the pins are not displaced by more than 1mm		N/A
	Each pin subjected to a torque of 0.4Nm; the pins are not rotating unless rotating does not impair compliance with the standard		N/A

IEC 60335-2-29			
Clause	Requirement - Test	Result - Remark	Verdict
22.4	Appliance for heating liquids and appliance causing undue vibration not provided with pins for insertion into socket-outlets		N/A
22.5	No risk of electric shock when touching the pins of the plug, the appliance being disconnected from the supply at the instant of voltage peak.	34V within 1s.	P
22.6	Electrical insulation not affected by condensing water or leaking liquid	No water or liquid.	N/A
	Electrical insulation of Class II appliances not affected in case of a hose rupture or seal leak		N/A
22.7	Adequate safeguards against the risk of excessive pressure in appliances provided with steam-producing devices	No steam-producing devices.	N/A
22.8	Electrical connections not subject to pulling during cleaning of compartments to which access can be gained without the aid of a tool, and that are likely to be cleaned in normal use		P
22.9	Insulation, internal wiring, windings, commutators and slip rings not exposed to oil, grease or similar substances		P
	Adequate insulating properties of oil or grease to which insulation is exposed	No oil or greases provided.	N/A
22.10	Not possible to reset voltage-maintained non-self-resetting thermal cut-outs by the operation of an automatic switching device incorporated within the appliance		N/A
	Non-self resetting thermal motor protectors have a trip-free action, unless	No thermal motor-protectors.	N/A
	they are voltage maintained		N/A
	Location or protection of reset buttons of non-self-resetting controls is so that accidental resetting is unlikely		N/A

IEC 60335-2-29			
Clause	Requirement - Test	Result - Remark	Verdict
22.11	Reliable fixing of non-detachable parts that provide the necessary degree of protection against electric shock, moisture or contact with moving parts	Enclosures fixed by one screw.	P
	Obvious locked position of snap-in devices used for fixing such parts	No snap-in devices.	N/A
	No deterioration of the fixing properties of snap-in devices used in parts that are likely to be removed during installation or servicing	Ditto,	N/A
	Tests as described		P
22.12	Handles, knobs etc. fixed in a reliable manner	No such constructions.	N/A
	Fixing in wrong position of handles, knobs etc. indicating position of switches or similar components not possible		N/A
	Axial force 15 N applied to parts, the shape being so that an axial pull is unlikely to be applied		N/A
	Axial force 30 N applied to parts, the shape being so that an axial pull is likely to be applied		N/A
22.13	Unlikely that handles, when gripped as in normal use, make the operators hand touch parts having a temperature rise exceeding the value specified for handles which are held for short periods only		N/A
22.14	No ragged or sharp edges creating a hazard for the user in normal use, or during user maintenance	No sharp edges of enclosures.	P
	No exposed pointed ends of self tapping screws etc., liable to be touched by the user in normal use or during user maintenance	Compliance checked.	P
22.15	Storage hooks and the like for flexible cords smooth and well rounded	No storage hooks.	N/A
22.16	Automatic cord reels cause no undue abrasion or damage to the sheath of the flexible cord, no breakage of conductors strands, no undue wear of contacts	No cord reels.	N/A
	Cord reel tested with 6000 operations, as specified		N/A
	Electric strength test of 16.3, voltage of 1000 V applied		N/A
22.17	Spacers not removable from the outside by hand or by means of a screwdriver or a spanner	No spacers.	N/A
22.18	Current-carrying parts and other metal parts resistant to corrosion under normal conditions of use		P
22.19	Driving belts not used as electrical insulation	No driving belts.	N/A
22.20	Direct contact between live parts and thermal insulation effectively prevented, unless material used is non-corrosive, non-hygroscopic and non-combustible	No thermal insulation material.	N/A
	Compliance is checked by inspection and, if necessary, by appropriate test		N/A

IEC 60335-2-29			
Clause	Requirement - Test	Result - Remark	Verdict
22.21	Wood, cotton, silk, ordinary paper and fibrous or hygroscopic material not used as insulation, unless impregnated	No such material.	P
22.22	Appliances not containing asbestos	Not used.	P
22.23	Oils containing polychlorinated biphenyl (PCB) not used	Not used.	P
22.24	Bare heating elements adequately supported	No heating elements.	N/A
	In case of rupture, the heating conductor is unlikely to come in contact with accessible metal parts		N/A
22.25	Sagging heating conductors cannot come into contact with accessible metal parts		N/A
22.26	Output circuit supplied through a safety isolating transformer (IEC 60335-2-29)	Safety isolating transformer (T1) provided.	P
	No connection between the output circuit and accessible metal parts or an earthing terminal (IEC 60335-2-29)		P
	Insulation between parts operating at safety extra- low voltage and live parts complies with the requirements for double or reinforced insulation (IEC 60335-2-29)		P
22.27	Parts connected by protective impedance separated by double or reinforced insulation	Two Y1 capacitors (C30/C31) provided between primary and secondary.	P
22.28	Metal parts of Class II appliances conductively connected to gas pipes or in contact with water: separated from live parts by double or reinforced insulation	No gas or water.	N/A
22.29	Class II appliances permanently connected to fixed wiring so constructed that the required degree of access to live parts is maintained after installation		N/A
22.30	Parts serving as supplementary or reinforced insulation fixed so that they cannot be removed without being seriously damaged, or		N/A
	so constructed that they cannot be replaced in an incorrect position, and so that if they are omitted, the appliance is rendered inoperable or manifestly incomplete		P
22.31	Clearances and creepage distances over supplementary and reinforced insulation not reduced below values specified in clause 29 as a result of wear	Internal wires for switch and voltage selector are fixed by soldering and heat shrinkage tube.	P
	Clearances and creepage distances between live parts and accessible parts not reduced below values for supplementary insulation, if wires, screws etc. become loose		N/A
22.32	Supplementary and reinforced insulation designed or protected against deposition of dirt or dust		P



IEC 60335-2-29			
Clause	Requirement - Test	Result - Remark	Verdict
	Supplementary insulation of natural or synthetic rubber resistant to ageing, or arranged and dimensioned so that creepage distances are not reduced below values specified in 29.2		N/A
	Ceramic material not tightly sintered, similar material or beads alone not used as supplementary or reinforced insulation		N/A
	Oxygen bomb test at 70 °C for 96 h and 16 h at room temperature		N/A
22.33	Conductive liquids that are or may become accessible in normal use are not in direct contact with live parts	No liquids.	N/A
	Electrodes not used for heating liquids		N/A
	For class II constructions, conductive liquids that are or may become accessible in normal use, not in direct contact with basic or reinforced insulation		N/A
	For class II constructions, conductive liquids which are in contact with live parts, not in direct contact with reinforced insulation		N/A
22.34	Shafts of operating knobs, handles, levers etc. not live, unless the shaft is not accessible when the part is removed	No knobs, handles or levers.	N/A
22.35	Handles, levers and knobs, held or actuated in normal use, not becoming live in the event of an insulation fault		N/A
	Such parts being of metal, and their shafts or fixings are likely to become live in the event of an insulation fault, they are either adequately covered by insulation material, or their accessible parts are separated from their shafts or fixings by supplementary insulation		N/A
	This requirement does not apply to handles, levers and knobs on stationary appliances other than those of electrical components, provided they are either reliably connected to an earthing terminal or earthing contact, or separated from live parts by earthed metal		N/A
22.36	Handles continuously held in the hand in normal use are so constructed that when gripped as in normal use, the operators hand is not likely to touch metal parts, unless they are separated from live parts by double or reinforced insulation		N/A
22.37	Capacitors in Class II appliances not connected to accessible metal parts, unless complying with 22.42	See 22.42.	P
	Metal casings of capacitors in Class II appliances separated from accessible metal parts by supplementary insulation, unless complying with 22.42		N/A
22.38	Capacitors not connected between the contacts of a thermal cut-out	No thermal cut-outs.	N/A

IEC 60335-2-29			
Clause	Requirement - Test	Result - Remark	Verdict
22.39	Lamp holders used only for the connection of lamps	No lamp holders.	N/A
22.40	Motor-operated appliances and combined appliances intended to be moved while in operation, or having accessible moving parts, fitted with a switch to control the motor. The actuating member of the switch being easily visible and accessible		N/A
22.41	No components, other than lamps, containing mercury		P
22.42	Protective impedance consisting of at least two separate components	Two Y1 capacitors (C30/C31) provided.	P
	Values specified in 8.1.4 not exceeded if any one of the components are short-circuited or open-circuited	See 8.1.4.	P
22.43	Appliances adjustable for different voltages, accidental changing of the setting of the voltage unlikely to occur		P
22.44	Appliances are not allowed to have an enclosure that is shaped and decorated so that the appliance is likely to be treated as a toy by children		P
22.45	When air is used as reinforced insulation, clearances not reduced below the values specified in 29.1.4 due to deformation as a result of an external force applied to the enclosure		P
22.46	Software used in protective electronic circuits is software class B or C .....		N/A
22.47	Appliances connected to the water mains withstand the water pressure expected in normal use	Not connected to water.	N/A
	No leakage from any part, including any inlet water hose		N/A
22.48	Appliances connected to the water mains constructed to prevent back siphonage of non-potable water		N/A
22.101	Conductors for connection to the terminals of the battery coloured as specified (IEC 60335-2-29)	O/P connector used and + / - marked near terminal.	P
22.102	Each circuit supplied from a d.c. distribution board incorporates an overload protective device (IEC 60335-2-29)	No d.c. distribution boards.	N/A
22.103	Battery chargers for installing in caravans or similar vehicles constructed so that they can be securely fixed to a support (IEC 60335-2-29)	Not used in caravans.	N/A
23	INTERNAL WIRING		P
23.1	Wireways smooth and free from sharp edges		P
	Wires protected against contact with burrs, cooling fins etc.		N/A
	Wire holes in metal well rounded or provided with bushings	No wire holes.	N/A

IEC 60335-2-29			
Clause	Requirement - Test	Result - Remark	Verdict
	Wiring effectively prevented from coming into contact with moving parts		P
23.2	Beads etc. on live wires cannot change their position, and are not resting on sharp edges or corners		N/A
	Beads inside flexible metal conduits contained within an insulating sleeve		N/A
23.3	Electrical connections and internal conductors movable relatively to each other not exposed to undue stress	No such constructions.	N/A
	Flexible metallic tubes not causing damage to insulation of conductors		N/A
	Open-coil springs not used		N/A
	Adequate insulating lining provided inside a coiled spring, the turns of which touch one another		N/A
	No damage after 10 000 flexings for conductors flexed during normal use or 100 flexings for conductors flexed during user maintenance		N/A
	Electric strength test, 1000 V between live parts and accessible metal parts		N/A
23.4	Bare internal wiring sufficiently rigid and fixed	No bare internal wiring.	N/A
23.5	The insulation of internal wiring withstanding the electrical stress likely to occur in normal use		N
	No breakdown when a voltage of 2000 V is applied for 15 min between the conductor and metal foil wrapped around the insulation		N/A
23.6	Sleeving used as supplementary insulation on internal wiring retained in position by positive means	No sleeving used as supplementary insulation.	N/A
23.7	The colour combination green/yellow used only for earthing conductors		P
23.8	Aluminium wires not used for internal wiring	No aluminium wires.	P
23.9	No lead-tin soldering of stranded conductors where they are subject to contact pressure, unless	Appliance inlet provided.	N/A
	clamping means so constructed that there is no risk of bad contact due to cold flow of the solder		N/A
23.10	The insulation and sheath of internal wiring, incorporated in external hoses for the connection of an appliance to the water mains, at least equivalent to that of light polyvinyl chloride sheathed flexible cord (60227 IEC 52)		N/A
24	COMPONENTS		P
24.1	Components comply with safety requirements in relevant IEC standards		P

IEC 60335-2-29				
Clause	Requirement - Test	Result - Remark	Verdict	
	List of components	(See appended table)	P	
	Components not tested and found to comply with relevant IEC standard for the number of cycles specified are tested in accordance with 24.1.1 to 24.1.6		P	
	Components not tested and found to comply with relevant IEC standard, components not marked or not used in accordance with its marking, tested under the conditions occurring in the appliance		P	
24.1.1	Capacitors likely to be permanently subjected to the supply voltage and used for radio interference suppression or for voltage dividing, complying with IEC 60384-14, or	Approved X capacitor (C1) provided.	P	
	tested according to annex F		N/A	
24.1.2	Safety isolating transformers complying with IEC 61558-2-6, or	See below.	N/A	
	tested according to annex G	Transformer (T1) tested within the appliance, see annex G.	P	
24.1.3	Switches complying with IEC 61058-1, the number of cycles of operation being at least 10 000, or	Approved switches.	P	
	tested according to annex H		N/A	
	If the switch operates a relay or contactor, the complete switching system is subjected to the test		N/A	
24.1.4	Automatic controls complying with IEC 60730-1 with relevant part 2. The number of cycles of operation being:		N/A	
	- thermostats:	10 000	No automatic controls.	N/A
	- temperature limiters:	1 000		N/A
	- self-resetting thermal cut-outs:	300		N/A
	- voltage maintained non-self-resetting thermal cut-outs:	1000		N/A
	- other non-self-resetting thermal cut-outs:	30		N/A
	- timers:	3 000		N/A
	- energy regulators:	10 000		N/A
	Thermal motor protectors are tested in combination with their motor under the conditions specified in Annex D	No thermal motor protectors.	N/A	
	For water valves containing live parts and that are incorporated in external hoses for connection of an appliance to the water mains, the degree of protection declared for subclause 6.5.2 of IEC 60730-2-8 is IPX7	No such components.	N/A	
24.1.5	Appliance couplers complying with IEC 60320-1	Approved appliance inlet provided.	P	

IEC 60335-2-29			
Clause	Requirement - Test	Result - Remark	Verdict
	However, appliances classified higher than IPX0, the appliance couplers complying with IEC 60320-2-3	IP20.	N/A
	Interconnection couplers complying with IEC 60320-2-2	No interconnection couplers.	N/A
24.1.6	Small lamp holders similar to E10 lampholders complying with IEC 60238, the requirements for E10 lampholders being applicable	No lamp holders.	N/A
24.2	No switches or automatic controls in flexible cords	No power cord provided.	N/A
	No devices causing the protective device in the fixed wiring to operate in the event of a fault in the appliance		P
	No thermal cut-outs that can be reset by soldering	No thermal cut-outs.	P
24.3	Switches intended for all-pole disconnection of stationary appliances are directly connected to the supply terminals and having a contact separation in all poles, providing full disconnection under overvoltage category III conditions		N/A
24.4	Plugs and socket-outlets for extra-low voltage circuits and heating elements, not interchangeable with plugs and socket-outlets listed in IEC 60083 or IEC 60906-1 or with connectors and appliance inlets complying with the standard sheets of IEC 60320-1	No socket-outlets.	N/A
24.5	Capacitors in auxiliary windings of motors marked with their rated voltage and capacitance and used accordingly	No motors.	N/A
	Voltage across capacitors in series with a motor winding does not exceed 1,1 times rated voltage, when the appliance is supplied at 1,1 times rated voltage under minimum load		N/A
24.6	Working voltage of motors connected to the supply mains and having basic insulation that is inadequate for the rated voltage of the appliance, not exceeding 42V		N/A
	In addition, the motors are complying with the requirements of Annex I		N/A
24.7	Hose-sets for connection of appliances to the water mains, complying with IEC 61770 and supplied with the appliance	Not connected to water mains.	N/A
25	SUPPLY CONNECTION AND EXTERNAL FLEXIBLE CORDS		P
25.1	Appliance not intended for permanent connection to fixed wiring, means for connection to the supply:		P
	- supply cord fitted with a plug	See below.	N/A
	- an appliance inlet having at least the same degree of protection against moisture as required for the appliance	Appliance inlet provided.	P

IEC 60335-2-29			
Clause	Requirement - Test	Result - Remark	Verdict
	- pins for insertion into socket-outlets	See above.	N/A
25.2	Appliance not provided with more than one means of connection to the supply mains	Single supply.	P
	Stationary appliance for multiple supply may be provided with more than one means of connection, provided electric strength test of 1250 V for 1 min between each means of connection causes no breakdown		N/A
25.3	Connection of supply conductors for appliance intended to be permanently connected to fixed wiring possible after the appliance has been fixed to its support	Appliance inlet provided.	N/A
	Appliance provided with a set of terminals for the connection of cables or fixed wiring, cross-sectional areas specified in 26.6		N/A
	Appliance provided with a set of terminals allowing the connection of a flexible cord		N/A
	Appliance provided with a set of supply leads accommodated in a suitable compartment		N/A
	Appliance provided with a set of terminals and cable entries, conduit entries, knock-outs or glands, allowing connection of appropriate type of cable or conduit		N/A
25.4	Cable and conduit entries, rated current of appliance not exceeding 16 A, dimension according to table 10		N/A
	Introduction of conduit or cable does not reduce clearances or creepage distances below values specified in 29		N/A
25.5	Method for assemble supply cord with the appliance:		N/A
	- type X attachment	Appliance inlet provided.	N/A
	- type Y attachment		N/A
	- type Z attachment, if allowed in part 2		N/A
	Type X attachment, other than those with a specially prepared cord, not used for flat twin tinsel cords		N/A
25.6	Plugs fitted with only one flexible cord	No power cord provided.	N/A
25.7	Supply cord not lighter than:		N/A
	- braided cord (60245 IEC 51)	No power cord provided.	N/A
	- ordinary tough rubber sheathed cord (60245 IEC 53)		N/A
	- ordinary polychloroprene sheathed flexible cord (60245 IEC 57)		N/A
	- flat twin tinsel cord (60227 IEC 41)		N/A

IEC 60335-2-29			
Clause	Requirement - Test	Result - Remark	Verdict
	- light polyvinyl chloride sheathed cord (60227 IEC 52), appliance not exceeding 3 kg		N/A
	- ordinary polyvinyl chloride sheathed cord (60227 IEC 53), appliance exceeding 3 kg		N/A
	Natural rubber supply cords not used for battery chargers for charging automobile batteries		N/A
	Temperature rise of external metal parts exceeding 75 K, PVC cord not used, unless		N/A
	appliance so constructed that the supply cord is not likely to touch external metal parts in normal use, or		N/A
	the supply cord is appropriate for higher temperatures, type Y or type Z attachment used		N/A
25.8	Nominal cross-sectional area of supply cords according to table 11; rated current (A); cross-		N/A
25.9	Supply cord not in contact with sharp points or edges		P
25.10	Green/yellow core for earthing purposes in Class I appliance		P
25.11	Conductors of supply cords not consolidated by lead-tin soldering where they are subject to contact	No power cord provided.	N/A
	clamping means so constructed that there is no risk of bad contacts due to cold flow of the solder		N/A
25.12	Moulding the cord to part of the enclosure does not damage the insulation of the supply cord		N/A
25.13	Inlet opening so shaped as to prevent damage to the supply cord	Appliance inlet provided.	N/A
	Unless the enclosure at the inlet opening is of insulation material, a non-detachable lining or bushing complying with 29.3 for supplementary insulation provided		N/A
	If unsheathed supply cord, a similar additional bushing or lining is required, unless		N/A
	the appliance is class 0		N/A
25.14	Supply cords adequately protected against excessive flexing		N/A
	Flexing test:		N/A
	- applied force (N).....:		N/A
	- number of flexings.....:		N/A
	The test does not result in:		N/A
	- short circuit between the conductors		N/A
	- breakage of more than 10% of the strands of any		N/A
	- separation of the conductor from its terminal		N/A
	- loosening of any cord guard		N/A

IEC 60335-2-29			
Clause	Requirement - Test	Result - Remark	Verdict
	- damage, within the meaning of the standard, to the		N/A
	- broken strands piercing the insulation and		N/A
25.15	Conductors of the supply cord relieved from strain,	Appliance inlet provided.	N/A
	The cord cannot be pushed into the appliance to		N/A
	Pull and torque test of supply cord, values shown in		N/A
	Max. 2 mm displacement of the cord, and		N/A
	Creepage distances and clearances not reduced		N/A
25.16	Cord anchorages for type X attachments constructed and located so that:		N/A
	- replacement of the cord is easily possible	Appliance inlet provided.	N/A
	- it is clear how the relief from strain and the prevention of twisting are obtained		N/A
	- they are suitable for different types of cord		N/A
	- cord cannot touch the clamping screws of cord anchorage if these screws are accessible, unless separated from accessible metal parts by supplementary insulation		N/A
	- the cord is not clamped by a metal screw which bears directly on the cord		N/A
	- at least one part of the cord anchorage securely fixed to the appliance, unless part of a specially prepared cord		N/A
	- screws which have to be operated when replacing the cord do not fix any other component, if applicable		N/A
	- if labyrinths can be bypassed the test of 25.15 is nevertheless withstood		N/A
	- for Class 0, 0I and I appliances: they are of insulating material or are provided with an		N/A
	- for Class II appliances: they are of insulating material, or if of metal, they are insulated from		N/A
25.17	Adequate cord anchorages for type Y and Z attachment		N/A
25.18	Cord anchorages only accessible with the aid of a tool, or		N/A
	so constructed that the cord can only be fitted with the aid of a tool		N/A
25.19	Type X attachment, glands not used as cord anchorage in portable appliances		N/A
	Tying the cord into a knot or tying the cord with string not used		N/A
25.20	Conductors of the supply cord for type Y and Z attachment adequately additionally insulated		N/A



IEC 60335-2-29			
Clause	Requirement - Test	Result - Remark	Verdict
25.21	Space for supply cord for type X attachment or for connection of fixed wiring constructed to		N/A
	For portable appliances, the uninsulated end of a conductor prevented from any contact with		N/A
25.22	Appliance inlet:		P
	- live parts not accessible during insertion or removal		P
	- connector can be inserted without difficulty		P
	- the appliance is not supported by the connector		P
	- is not for cold conditions if temp. rise of external metal parts exceeds 75 K, unless the supply cord is not likely to touch such metal parts		P
25.23	Interconnection cords comply with the requirements for the supply cord, except as specified	No interconnection cords.	N/A
	If necessary, electric strength test of 16.3		N/A
25.24	Interconnection cords not detachable without the aid of a tool if compliance with the standard is impaired when they are disconnected		N/A
25.25	Dimensions of pins compatible with the dimensions of the relevant socket-outlet. Dimensions of pins and engagement face in accordance with the relevant plug in IEC 60083		N/A
26	TERMINALS FOR EXTERNAL CONDUCTORS	<input type="checkbox"/> Appliance inlet provided.	N/A
26.1	Appliances provided with terminals or equally effective devices for connection of external conductors		N/A
	Terminals only accessible after removal of a non-detachable cover		N/A
	However, earthing terminals may be accessible if a tool is required to make the connections and means are provided to clamp the wire independently from its connection		N/A
26.2	Appliances with type X attachment and appliances for connection to fixed wiring provided with terminals in which connections are made by means of screws, nuts or similar devices, unless the connections are soldered		N/A
	Screws and nuts serve only to clamp supply conductors, except		N/A
	internal conductors, if so arranged that they are unlikely to be displaced when fitting the supply conductors		N/A
	If soldered connections used, the conductor so positioned or fixed that reliance is not placed on soldering alone		N/A

IEC 60335-2-29			
Clause	Requirement - Test	Result - Remark	Verdict
	Soldering alone used, barriers provided, clearances and creepage distances satisfactory if the conductor becomes free at the soldered joint		N/A
26.3	Terminals for type X attachment and for connection to fixed wiring so constructed that the conductor is clamped between metal surfaces with sufficient contact pressure and without damaging the conductor		N/A
	Terminals for type X attachment and those for connection to fixed wiring so fixed that when tightening or loosening the clamping means:		N/A
	- the terminal does not loosen		N/A
	- internal wiring is not subjected to stress		N/A
	- clearances and creepage distances are not		N/A
	Compliance checked by inspection and by the test of		N/A
26.4	Terminals for type X attachment, except those with a		N/A
26.5	Terminals for type X attachment so located or		N/A
	Stranded conductor test, 8 mm insulation removed		N/A
	No contact between live parts and accessible metal		N/A
26.6	Terminals for type X attachment and for connection		N/A
	Terminals only suitable for a specially prepared cord		N/A
26.7	Terminals for type X attachment accessible after		N/A
26.8	Terminals for the connection to fixed wiring,		N/A
26.9	Terminals of the pillar type constructed and located		N/A
26.10	Terminals with screw clamping and screwless		N/A
	Pull test of 5 N to the connection		N/A
26.11	For type Y and Z attachment: soldered, welded,		N/A
	For Class II appliances: the conductor so positioned or fixed that reliance is not placed on soldering, welding or crimping alone		N/A
	For Class II appliances: soldering, welding or crimping alone used, barriers provided, clearances and creepage distances satisfactory if the conductor becomes free		N/A
27	PROVISION FOR EARTHING		P
27.1	Accessible metal parts of Class 0I and I appliances, permanently and reliably connected to an earthing terminal or contact of the appliance inlet		P
	Earthing terminals not connected to neutral terminal		P
	Class 0, II and III appliance have no provision for earthing		N/A

IEC 60335-2-29			
Clause	Requirement - Test	Result - Remark	Verdict
	Safety extra-low voltage circuits not earthed, unless protective extra-low voltage circuits	Separated by a Y capacitor.	P
27.2	Clamping means adequately secured against accidental loosening		P
	Terminals used for the connection of external equipotential bonding conductors allow connection of conductors of 2.5 to 6 mm <sup>2</sup> , and		N/A
	do not provide earthing continuity between different parts of the appliance		P
	Conductors cannot be loosened without the aid of a tool	Tool is needed.	P
27.3	For detachable parts that are plugged into another part of the appliance, and having an earth connection, the earth connection made before and separated after current-carrying connections when removing the part		N/A
	For appliances with supply cord, current-carrying conductors become taut before earthing conductor, if the cord slips out of the cord anchorage	No supply cord used.	N/A
27.4	No risk of corrosion resulting from contact between metal of earthing terminal and other metal		P
	Adequate resistance to corrosion of coated or uncoated parts providing earthing continuity, other than parts of a metal frame or enclosure		P
	Parts of steel providing earthing continuity provided at the essential areas with an electroplated coating, thickness at least 5 μm		N/A
	Adequate protection against rusting of parts of coated or uncoated steel, only intended to provide or transmit contact pressure		N/A
	In case of aluminium alloys precautions taken to avoid risk of corrosion		P
27.5	Low resistance of connection between earthing terminal and earthed metal parts		P
	This requirement does not apply to connections providing earthing continuity in the protective extra-low voltage circuit, provided that clearances of basic insulation are based on the rated voltage of the appliance		P
	Resistance not exceeding 0,1 Ω at the specified low-resistance test	0.056Ω < 0,1 Ω (inlet to metal case)	P
27.6	The printed conductors of printed circuit boards not used to provide earthing continuity in hand held appliances		N/A
	They may be used in other appliances if:		N/A

IEC 60335-2-29			
Clause	Requirement - Test	Result - Remark	Verdict
	- at least two tracks are used with independent soldering points and the appliance complies with requirements of 27.5 for each circuit		N/A
	- the material of the printed circuit board complies with IEC 60249-2-4 or IEC 60249-2-5		N/A
28	SCREWS AND CONNECTIONS		P
28.1	Fixings, electrical connections and connections providing earthing continuity withstand mechanical stresses		P
	Screws not of soft metal liable to creep, such as zinc or aluminium	Metal screw provided.	P
	Diameter of screws of insulating material min. 3 mm		N/A
	Screws of insulating material not used for any electrical connection or connections providing earthing continuity		N/A
	Screws used for electrical connections or connections providing earthing continuity screw into metal		P
	Screws not of insulating material if their replacement by a metal screw can impair supplementary or reinforced insulation		P
	Type X attachment, screws to be removed for replacement of supply cord or for user maintenance, not of insulating material if their replacement by a metal screw can impair basic insulation	No user maintenance.	N/A
	For screws and nuts; test as specified	(See appended table)	N/A
28.2	Electrical connections and connections providing earthing continuity constructed so that contact pressure not transmitted through insulating material liable to shrink or distort, unless shrinkage or distortion compensated	No electrical connection or earthing continuity.	P
	This requirement does not apply to electrical connections in circuits carrying a current not exceeding 0.5A		N/A
28.3	Space-threaded (sheet metal) screws only used for electrical connections if they clamp the parts together		P
	Thread-cutting (self-tapping) screws only used for electrical connections if they generate a full form standard machine screw thread	Not used such kind of screw.	N/A
	Such screws not used if they are likely to be operated by the user or installer unless the thread is formed by a swaging action		N/A

IEC 60335-2-29			
Clause	Requirement - Test	Result - Remark	Verdict
	Thread-cutting and space-threaded screws may be used in connections providing earthing continuity, provided unnecessary to disturb the connection and at least two screws are used for each connection		P
28.4	Screws and nuts that make mechanical connection secured against loosening if they also make electrical connections or connections providing earthing continuity		P
	Rivets for electrical connections or connections providing earthing continuity secured against loosening if subjected to torsion		N/A
29	CLEARANCES, CREEPAGE DISTANCES AND SOLID INSULATION		P
	Clearances, creepage distances and solid insulation withstand electrical stress		P
	For coatings used on printed circuits boards to protect the microenvironment (Type A) or to provide basic insulation (Type B), annex J applies .....	No coating used on PCB.	N/A
	The microenvironment is pollution degree 1 under Type A coating		N/A
	No creepage distance or clearance requirements under Type B coating		N/A
29.1	Clearances not less than the values specified in table 16, taking into account the rated impulse voltage for the overvoltage categories of table 15, unless	Overvoltage category II, impulse voltage 2500 V.	P
	for basic insulation and functional insulation they comply with the impulse voltage test of clause 14		N/A
	However, if the construction is affected by wear, distortion, movement of the parts or during assembly,		P
	Impulse voltage test not applicable:		N/A
	- when the microenvironment is pollution degree 3		N/A
	- for basic insulation of class 0 and class 01 appliances		N/A
	Appliances are in overvoltage category II	Category II.	P
	Clearances less than specified in table 16 not allowed for basic insulation of class 0 and class 01 appliances,	Class I appliance.	N/A
	or if pollution degree 3 is applicable	Pollution degree 2.	N/A
	Compliance is checked by inspection and measurements as specified		P
29.1.1	Clearances of basic insulation withstand the overvoltages, taking into account the rated impulse voltage	Impulse voltage 2500 V.	P

IEC 60335-2-29			
Clause	Requirement - Test	Result - Remark	Verdict
	Clearance at the terminals of tubular sheathed heating elements may be reduced to 1mm if the microenvironment is pollution degree 1	No heating elements.	N/A
	Lacquered conductors of windings considered to be bare conductors		P
29.1.2	Clearances of supplementary insulation not less than those specified for basic insulation in table 16		P
29.1.3	Clearances of reinforced insulation not less than those specified for basic insulation in table 16, but using the next higher step for rated impulse voltage		P
29.1.4	For functional insulation, the values of table 16 are applicable, unless		P
	the appliance complies with clause 19 with the functional insulation short-circuited		N/A
	Lacquered conductors of windings considered to be bare conductors		P
	However, clearances at crossover points are not measured		N/A
	Clearance between surfaces of PTC heating elements may be reduced to 1mm	No heating elements.	N/A
29.1.5	Appliances having higher working voltage than rated voltage, the voltage used for determining		N/A
	If the secondary winding of a step-down transformer is earthed, or if there is an earthed		N/A
	Circuits supplied with a voltage lower than rated voltage, clearances of functional		N/A
29.2	Creepage distances not less than those appropriate for the working voltage, taking into		P
	Pollution degree 2 applies, unless	Pollution degree 2.	P
	precautions taken to protect the insulation; pollution degree 1		N/A
	insulation subjected to conductive pollution; pollution degree 3		N/A
	Compliance is checked by inspection and measurements as specified		P
29.2.1	Creepage distances of basic insulation not less than specified in table 17		P
	For pollution degree 1, creepage distance not less than the minimum specified for the	Pollution degree 2.	N/A
29.2.2	Creepage distances of supplementary insulation at least as specified for basic		P
29.2.3	Creepage distances of reinforced insulation at least double as specified for basic insulation in		P

IEC 60335-2-29			
Clause	Requirement - Test	Result - Remark	Verdict
29.2.4	Creepage distances of functional insulation not less than specified in table 18	See 29.2.	P
	Creepage distances may be reduced if the appliance complies with clause 19 with the functional insulation short-circuited		N/A
29.3	Supplementary and reinforced insulation having adequate thickness, or a sufficient number of layers, to withstand the electrical stresses		P
	Compliance checked by:		P
	- measurement, in accordance with 29.3.1, or		N/A
	- an electric strength test in accordance with 29.3.2, or	See 29.3.2.	P
	- an assessment of the thermal quality of the material combined with an electric strength test, in accordance with 29.3.3		N/A
29.3.1	Supplementary insulation having a thickness of at least 1 mm		N/A
	Reinforced insulation having a thickness of at least 2 mm		N/A
29.3.2	Each layer of material withstand the electric strength test of 16.3 for supplementary insulation	Insulation tape for transformer.	P
	Supplementary insulation consisting of at least 2 layers		N/A
	Reinforced insulation consisting of at least 3 layers	3 layers used between primary and secondary.	P
29.3.3	The insulation is subjected to the dry heat test Bb of IEC 60068-2-2, followed by		N/A
	the electric strength test of 16.3		N/A
	If the temperature rise during the tests of Clause 19 does not exceed the value specified in Table 3, the test of IEC 60068-2-2 is not carried out		N/A
30	RESISTANCE TO HEAT AND FIRE		P
30.1	External parts of non-metallic material,	Metal enclosure.	N/A
	parts supporting live parts, and	For appliance inlet and transformer bobbin.	P
	thermoplastic material providing supplementary or reinforced insulation,		N/A
	sufficiently resistant to heat		P
	Ball-pressure test according to IEC 60695-10-2		P
	External parts: at 40 °C plus the maximum temperature rise determined during the test of clause 11, or at 75 °C, whichever is the higher; temperature ( °C).....:		N/A

IEC 60335-2-29			
Clause	Requirement - Test	Result - Remark	Verdict
	Parts supporting live parts: at 40 °C plus the maximum temperature rise determined during the test of clause 11, or at 125 °C, whichever is the higher; temperature ( °C) .....	(See appended table)	P
	Parts of thermoplastic material providing supplementary or reinforced insulation, 25 °C plus the maximum temperature rise determined during clause 19, if higher; temperature ( °C).....	(See appended table)	P
30.2	Relevant parts of non-metallic material adequately resistant to ignition and spread of fire		P
30.2.1	Glow-wire test of IEC 60695-2-11 at 550 °C, unless		N/A
	the material is classified at least HB40 according to IEC 60695-11-10		N/A
	Parts for which the glow-wire test cannot be carried out meet the requirements in ISO9772 for category HBF material		N/A
30.2.2	Appliances operated while attended, parts of insulating material supporting current-carrying connections and parts within a distance of 3mm subjected to the glow-wire test of IEC 60695-2-11 at a temperature of:		N/A
	-750°C, for connections carrying a current exceeding 0,5A during normal operation		N/A
	-650°C, for other connections		N/A
	Test not applicable to conditions as specified		N/A
30.2.3	Appliances operated while unattended, tested as specified in 30.2.3.1 and 30.2.3.2		P
	Test not applicable to conditions as specified		P
30.2.3.1	Parts of insulating material supporting connections carrying a current exceeding 0.2A during normal operation, and	Bobbin.	P
	parts of insulating material within a distance of 3mm,		P
	having a glow-wire flammability index of at least 850°C according to IEC 60695-2-12		P
30.2.3.2	Parts of insulating material supporting current-carrying connections, and		P
	parts of insulating material within a distance of 3mm,		N/A
	subjected to glow-wire test of IEC 60695-2-11		P
	Test not carried out on material having a glow-wire ignition temperature according to IEC 60695-2-13 as specified		N/A
	Glow-wire test of IEC 60695-2-11, the temperature being:		P
	-750°C, for connections carrying a current exceeding 0,2A during normal operation	For all material of transformer bobbin.	P
	-650°C, for other connections		N/A
	Parts that during the test produce a flame persisting longer than 2 s, tested as specified		N/A



IEC 60335-2-29			
Clause	Requirement - Test	Result - Remark	Verdict
	If a flame persists longer than 2 s during the test, parts above the connection, as specified, subjected to the needle-flame test of annex E, unless		N/A
	the material is classified as V-0 or V-1 according to IEC 60695-11-10		N/A
30.2.4	Base material of printed circuit boards subjected to needle-flame test of annex E	See annex E.	P
	Test not applicable to conditions as specified		P
31	RESISTANCE TO RUSTING		P
	Relevant ferrous parts adequately protected against rusting		P
32	RADIATION, TOXICITY AND SIMILAR HAZARDS		P
	Appliance does not emit harmful radiation		P
	Appliance does not present a toxic or similar hazard		P
A	ANNEX A (INFORMATIVE) ROUTINE TESTS		P
	Description of routine tests to be carried out by the manufacturer		P
	Test voltage of electric strength test between the input and output circuits (IEC 60335-2-29)		P
B	ANNEX B (NORMATIVE) APPLIANCES POWERED BY RECHARGEABLE BATTERIES		N/A
	The following modifications to this standard are applicable for appliances powered by batteries that are recharged in the appliance	Not powered by batteries.	N/A
	This annex does not apply to battery chargers		N/A
3.1.9	Appliance operated under the following conditions:		N/A
	-the appliance, supplied by its fully charged battery, operated as specified in relevant part 2		N/A
	-the battery is charged, the battery being initially discharged to such an extent that the appliance cannot operate		N/A
	-if possible, the appliance is supplied from the supply mains through its battery charger, the battery being initially discharged to such an extent that the appliance cannot operate. The appliance is operated as specified in relevant part 2		N/A

IEC 60335-2-29			
Clause	Requirement - Test	Result - Remark	Verdict
	If the appliance incorporates inductive coupling between two parts that are detachable from each other, the appliance is supplied from the supply mains with the detachable part removed		N/A
3.6.2	Part to be removed in order to discard the battery is not considered to be detachable		N/A
5.101	Appliances supplied from the supply mains tested as specified for motor-operated appliances		N/A
7.1	Battery compartment for batteries intended to be replaced by the user, marked with battery voltage and polarity of the terminals		N/A
7.12	The instructions for appliances incorporating batteries intended to be replaced by the user includes required information		N/A
	Details about how to remove batteries containing materials hazardous to the environment given		N/A
7.15	Markings placed on the part of the appliance connected to the supply mains		N/A
8.2	Appliances having batteries that according to the instruction may be replaced by the user need only have basic insulation between live parts and the inner surface of the battery compartment		N/A
	If the appliance can be operated without batteries, double or reinforced insulation required		N/A
11.7	The battery is charged for the period described		N/A
19.1	Appliances subjected to tests of 19.101, 19.102 and 19.103		N/A
19.101	Appliances supplied at rated voltage for 168 h, the battery being continually charged		N/A
19.102	Short-circuiting of the terminals of the battery, being fully charged, for appliances having batteries that can be removed without the aid of a tool		N/A
19.103	Appliances having batteries replaceable by the user supplied at rated voltage under normal operation with the battery removed or in any position allowed by the construction		N/A
21.101	Appliances having pins for insertion into socket- outlets have adequate mechanical strength, checked according to procedure 2 of IEC 68-2-32		N/A
	Part of the appliance incorporating the pins subjected to the free fall test, procedure 2, of IEC 60068-2-32, the number of falls being:		N/A
	- 100, the mass of part does not exceed 250 g		N/A
	- 50, the mass of part exceeds 250 g		N/A
	After the test, the requirements of 8.1, 15.1.1, 16.3 and clause 29 are met		N/A

IEC 60335-2-29			
Clause	Requirement - Test	Result - Remark	Verdict
22.3	Appliances having pins for insertion into socket-outlets tested as fully assembled as possible		N/A
25.13	An additional lining or bushing not required for interconnection cords operating at safety extra-low voltage		N/A
30.2	For parts of the appliance connected to the supply mains during the charging period, 30.2.3 applies		N/A
	For other parts, 30.2.2 applies		N/A
C	ANNEX C (NORMATIVE) AGEING TEST ON MOTORS		N/A
	Tests, as described, carried out when doubt with regard to the temperature classification of the insulation of a motor winding	No motors.	N/A
D	ANNEX D (NORMATIVE) THERMAL MOTOR PROTECTORS		N/A
	Applicable to appliances having motors that incorporate thermal motor protectors	No thermal motor protectors.	N/A
E	ANNEX E (NORMATIVE) NEEDLE-FLAME TEST		P
	Needle-flame test carried out in accordance with IEC 60695-2-2, with the following modifications:		P
5	Severities		P
	The duration of application of the test flame is 30 s ± 1 s	30 s.	P
8	Test procedure		P
8.2	The specimen so arranged that the flame can be applied to a vertical or horizontal edge as shown in the examples of figure 1		P
8.4	The first paragraph does not apply		P
	If possible, the flame is applied at least 10 mm from a corner		P
8.5	The test is carried out on one specimen		P
	If the specimen does not withstand the test, the test may be repeated on two further specimens, both withstanding the test		N/A
10	Evaluation of test results		P
	The duration of burning not exceeding 30 s		N/A
	However, for printed circuit boards, the duration of burning not exceeding 15 s	tb = 0 s.	P

IEC 60335-2-29			
Clause	Requirement - Test	Result - Remark	Verdict
F	ANNEX F (NORMATIVE) CAPACITORS		N/A
	Capacitors likely to be permanently subjected to the supply voltage, and used for radio interference suppression or voltage dividing, comply with the following clauses of IEC 60384-14, with the following modifications:	Approved X capacitor provided.	N/A
1.5	Terminology		N/A
1.5.3	Class X capacitors tested according to subclass X2		N/A
1.5.4	This subclause is applicable		N/A
1.6	Marking		N/A
	Items a) and b) are applicable		N/A
3.4	Approval testing		N/A
3.4.3.2	Table II is applicable as described		N/A
4.1	Visual examination and check of dimensions		N/A
	This subclause is applicable		N/A
4.2	Electrical tests		N/A
4.2.1	This subclause is applicable		N/A
4.2.5	This subclause is applicable		N/A
4.2.5.2	Only table IX is applicable		N/A
	Values for test A apply		N/A
	However, for capacitors in heating appliances the values for test B or C apply		N/A
4.12	Damp heat, steady state		N/A
	This subclause is applicable		N/A
	Only insulation resistance and voltage proof are checked		N/A
4.13	Impulse voltage		N/A
	This subclause is applicable		N/A
4.14	Endurance		N/A
	Subclauses 4.14.1, 4.14.3, 4.14.4 and 4.14.7 applicable		N/A
4.14.7	Only insulation resistance and voltage proof are checked		N/A
	Visual examination, no visible damage		N/A
4.17	Passive flammability test		N/A
	This subclause is applicable		N/A
4.18	Active flammability test		N/A

IEC 60335-2-29			
Clause	Requirement - Test	Result - Remark	Verdict
	This subclause is applicable		N/A
G	ANNEX G (NORMATIVE) SAFETY ISOLATING TRANSFORMERS		P
	The following modifications to this standard are applicable for safety isolating transformers:		P
7	Marking and instructions		P
7.1	Transformers for specific use marked with:		P
	-name, trademark or identification mark of the manufacturer or responsible vendor	Long sail or Yao Sheng or JET signal.	P
	-model or type reference	TF-1343 or TF-1344.	P
17	Overload protection of transformers and associated circuits		P
	Fail-safe transformers comply with subclause 15.5 of IEC 61558-1		N/A
22	Construction		P
	Subclauses 19.1 and 19.1.2 of IEC 61558-2-6 are applicable		P
29	Clearances, creepage distances and solid insulation		P
29.1, 29.2 and 29.3	The distances specified in items 2a, 2c and 3 in table 13 of IEC 61558-1 apply	See appended tables 29.	P
H	ANNEX H (NORMATIVE) SWITCHES		N/A
	Switches comply with the following clauses of IEC 61058-1, as modified:		N/A
	-The tests of IEC 61058-1 carried out under the conditions occurring in the appliance		N/A
	-Before being tested, switches are operated 20 times without load		N/A
8	Marking and documentation		N/A
	Switches are not required to be marked		N/A
	However, switches that can be tested separately from the appliance marked with the manufacturer's name or trade mark and the type reference		N/A
13	Mechanism		N/A
	The tests may be carried out on a separate sample		N/A
15	Insulation resistance and dielectric strength		N/A
15.1	Not applicable		N/A
15.2	Not applicable		N/A
15.3	Applicable for full disconnection and micro-disconnection		N/A

IEC 60335-2-29			
Clause	Requirement - Test	Result - Remark	Verdict
17	Endurance		N/A
	Compliance is checked on three separate appliances or switches		N/A
	For 17.2.4.4, the number of cycles is 10 000, unless otherwise specified in 24.1.3 of the relevant part 2 of IEC 60335		N/A
	Switches for operation under no load and which can be operated only by a tool and switches operated by hand that are interlocked so that they cannot be operated under load, are not subjected to the tests		N/A
	Subclauses 17.2.2 and 17.2.5.2 not applicable		N/A
	The ambient temperature during the test is that occurring in the appliance during the test of Clause 11 in IEC 60335-1		N/A
	Temperature rise of the terminals not more than 30 K above the temperature rise measured in clause 11 of IEC 60335-1		N/A
20	Clearances, creepage distances, solid insulation and coatings of rigid printed board assemblies		N/A
	This clause is applicable to clearances and creepage distances for functional insulation, across full disconnection and micro-disconnection, as stated in table 24		N/A
I	ANNEX I (NORMATIVE) MOTORS HAVING BASIC INSULATION THAT IS INADEQUATE FOR THE RATED VOLTAGE OF THE APPLIANCE		N/A
	The following modifications to this standard are applicable for motors having basic insulation that is inadequate for the rated voltage of the appliance:		N/A
8	Protection against access to live parts		N/A
8.1	Metal parts of the motor are considered to be bare live parts		N/A
11	Heating		N/A
11.3	Temperature rise of the body of the motor is determined instead of the temperature rise of the windings		N/A
11.8	Temperature rise of the body of the motor, where in contact with insulating material, not exceeding values in table 3 for the relevant insulating material		N/A
16	Leakage current and electric strength		N/A
16.3	Insulation between live parts of the motor and its other metal parts not subjected to the test		N/A
19	Abnormal operation		N/A

IEC 60335-2-29			
Clause	Requirement - Test	Result - Remark	Verdict
19.1	The tests of 19.7 to 19.9 not carried out		N/A
19.101	Appliance operated at rated voltage with each of the following fault conditions:		N/A
	- short circuit of the terminals of the motor, including any capacitor incorporated in the motor circuit		N/A
	- short circuit of each diode of the rectifier		N/A
	- open circuit of the supply to the motor		N/A
	- open circuit of any parallel resistor, the motor being in operation		N/A
	Only one fault simulated at a time, the tests carried out consecutively		N/A
22	Construction		N/A
22.101	For class I appliances incorporating a motor supplied by a rectifier circuit, the d.c. circuit being insulated from accessible parts of the appliance by double or reinforced insulation		N/A
	Compliance checked by the tests specified for double and reinforced insulation		N/A
J	ANNEX J (NORMATIVE) COATED PRINTED CIRCUIT BOARDS		N/A
	Testing of protective coatings of printed circuit boards carried out in accordance with IEC 60664-3 with the following modifications:		N/A
6.6	Climatic sequence		N/A
	When production samples are used, three samples of the printed circuit board are tested		N/A
6.6.1	Cold		N/A
	The test is carried out at -25°C		N/A
6.6.3	Rapid change of temperature		N/A
	Severity 1 is specified		N/A
6.8.6	Partial discharge extinction voltage		N/A
	Type A coatings not subjected to a partial discharge test		N/A
6.9	Additional tests		N/A
	This subclause is not applicable		N/A
K	ANNEX K (NORMATIVE) OVERVOLTAGE CATEGORIES		P
	The information on overvoltage categories is extracted from IEC 60664-1		P

IEC 60335-2-29			
Clause	Requirement - Test	Result - Remark	Verdict
	Overvoltage category is a numeral defining a transient overvoltage condition		P
	Equipment of overvoltage category IV is for use at the origin of the installation		N/A
	Equipment of overvoltage category III is equipment in fixed installations and for cases where the reliability and the availability of the equipment is subject to special requirements		N/A
	Equipment of overvoltage category II is energy consuming equipment to be supplied from the fixed installation		P
	If such equipment is subjected to special requirements with regard to reliability and availability, overvoltage category III applies		N/A
	Equipment of overvoltage category I is equipment for connection to circuits in which measures are taken to limit transient overvoltages to an appropriate low level		N/A
L	ANNEX L (INFORMATIVE) GUIDANCE FOR THE MEASUREMENT OF CLEARANCES AND CREEPAGE DISTANCES		P
	Sequences for the determination of clearances and creepage distances		P
M	ANNEX M (NORMATIVE) POLLUTION DEGREE		P
	The information on pollution degrees is extracted from IEC 60664-1		P
	Pollution		P
	The microenvironment determines the effect of pollution on the insulation, taking into account the microenvironment		P
	Means may be provided to reduce pollution at the insulation by effective enclosures or similar		P
	Minimum clearances specified where pollution may be present in the microenvironment		P
	Degrees of pollution in the microenvironment		P
	For evaluating creepage distances, the following degrees of pollution in the microenvironment are established:		P
	- pollution degree 1: no pollution or only dry, non-conductive pollution occurs. The pollution has no influence		N/A
	- pollution degree 2: only non-conductive pollution occurs, except that occasionally a temporary conductivity caused by condensation is to be		P



IEC 60335-2-29			
Clause	Requirement - Test	Result - Remark	Verdict
	expected		
	- pollution degree 3: conductive pollution occurs or dry non-conductive pollution occurs that becomes conductive due to condensation that is to be expected		N/A
	- pollution degree 4: the pollution generates persistent conductivity caused by conductive dust or by rain or snow		N/A
N	ANNEX N (NORMATIVE) PROOF TRACKING TEST		N/A
	The proof tracking test is carried out in accordance with IEC 60112 with the following modifications:		N/A
7	Test apparatus		N/A
7.3	Test solutions		N/A
	Test solution A is used		N/A
10	Determination of proof tracking index (PTI)		N/A
10.1	Procedure		N/A
	The proof voltage is 100V, 175V, 400V or 600V.....:		N/A
	The last paragraph of Clause 3 applies		N/A
	The test is carried out on five specimens		N/A
	In case of doubt, additional test with proof voltage reduced by 25V, the number of drops increased to 100		N/A
10.2	Report		N/A
	The report stating if the PTI value was based on a test using 100 drops with a test voltage of (PTI-25) V		N/A
O	ANNEX O (INFORMATIVE) SELECTION AND SEQUENCE OF THE TESTS OF CLAUSE 30		P
	Description of tests for determination of resistance to heat and fire		P
P	ANNEX P (INFORMATIVE) GUIDANCE FOR THE APPLICATION OF THIS STANDARD TO APPLIANCES USED IN WARM DAMP EQUABLE CLIMATES		N/A
	Modifications applicable for class 0 and 01 appliances having a rated voltage exceeding 150V, intended to be used in countries having a warm damp equable climate and that are marked WDaE		N/A
	Modifications may also be applied to class 1 appliances having a rated voltage exceeding 150V, intended to be used in countries having a warm damp equable climate and that are marked WdaE, if liable to be connected to a supply mains that excludes the protective earthing conductor		N/A

IEC 60335-2-29			
Clause	Requirement - Test	Result - Remark	Verdict
5	General conditions for the tests		N/A
5.7	The ambient temperature for the tests of Clauses 11 and 13 is 40 <sup>+3</sup> / <sub>0</sub>		N/A
7	Marking and instructions		N/A
7.1	The appliance marked with the letters WDaE		N/A
7.12	The instructions state that the appliance is to be supplied through a RCD having a rated residual operating current not exceeding 30 mA		N/A
	The instructions state that the appliance is considered to be suitable for use in countries having a warm damp equable climate, but may also be used in other countries		N/A
11	Heating		N/A
11.8	The values of Table 3 are reduced by 15 K		N/A
13	Leakage current and electric strength at operating temperature		N/A
13.2	The leakage current for class I appliances not exceeding 0,5 mA		N/A
15	Moisture resistance		N/A
15.3	The value of t is 37 °C		N/A
16	Leakage current and electric strength		N/A
16.2	The leakage current for class I appliances not exceeding 0,5 mA		N/A
19	Abnormal operation		N/A
19.13	The leakage current test of 16.2 is applied in addition to the electric strength test of 16.3		N/A
Q	ANNEX Q (INFORMATIVE) SEQUENCE OF TESTS FOR THE EVALUATION OF ELECTRONIC CIRCUITS		P
	Description of tests for appliances incorporating electronic circuits		P
R	ANNEX R (NORMATIVE) SOFTWARE EVALUATION		N/A
	Software evaluated in accordance with the following clauses of Annex H of IEC 60730-1, as modified		N/A
H.2	Definitions		N/A
	Only definitions H.2.16 to H.2.20 applicable		N/A
H.7	Information		N/A
	Only footnotes 12) to 18) of Table 7.2, as modified, applicable		N/A
H.11.12	Controls using software		N/A
	All the subclauses of H.11.12, as modified, except H.11.12.6 and H.11.12.6.1, applicable		N/A

IEC 60335-2-29			
Clause	Requirement - Test	Result - Remark	Verdict
H.11.12.7	Delete text		N/A
H.11.12.7.1	For appliances using software class C having a single channel with self-test and monitoring structure, the manufacturer provides the measures necessary to address the fault/errors in safety related segments and data		N/A
H.11.12.8	Software fault/error detection occurs before compliance with 19.13 of IEC 60335-1 is impaired		N/A
H.11.12.8.1	Replace text		N/A
H.11.12.13	Software and safety related hardware under its control initializes and terminates before compliance with 19.13 of IEC 60335-1 is impaired		N/A

11.8	TABLE: Heating test, thermocouples for model PB-300P-12		P
	Test voltage (V) .....	A: 90 / B: 264	-
	Ambient (°C).....	A: 40 / B: 29	-
Thermocouple locations		dT (K) A / B	Max. dT (K) A / B
Appliance inlet		7/15	30/ 45
CN1 body		16/22	45 / 45
C30 body		15/22	45 / 60
C2 body		20/24	45 / 60
LF1 coil		23/24	80/95
LF2 coil		48/25	80/95
PCB near RTH1		24/24	90 / 105
L2 coil		9/23	80/ 95
C5 body		25/31	45/ 60
HS body of Q2		16/27	90/ 105
HS body of D102		31/36	90/ 105
T1 top side coil		33/37	85(class B)/ 70
T1 bottom side coil		35/38	85(class B)/ 70
T1 core		30/45	-
L101 coil		36/42	80/ 70
U3 body		22/38	--
C31 body		26/37	45/60
Enclosure (inside) near T1*		14/22	--
Top of enclosure (outside) near T1*		9/18	--

13.2	TABLE: Leakage current		P
	Heating appliances: 1,15 x rated input.....		-
	Motor-operated and combined appliances: 1.06 x rated voltage .....	254	-
Leakage current between		I (mA)	Max. allowed I (mA)
Line and output		0.20	0.25
Neutral and output		0.17	0.25
Line and enclosure wrapped with metal foil*		3.25	3.5
Neutral and enclosure wrapped with metal foil*		1.65	3.5
* Fixed appliances.			

13.3	TABLE: Electric strength			P
Test voltage applied between: (all models)		Voltage (V)	Breakdown (Yes/No)	
Primary and earth		AC 1000	No	
Primary and output		AC 3000	No	
Primary and enclosure		AC 3000	No	

14	TABLE: Transient overvoltages					N
Clearance between:		CI (mm)	Required CI (mm)	Rated impulse voltage (V)	Impulse test voltage (V)	Flashover (Yes/No)

16.2	TABLE: Leakage current			P
Single phase appliances: 1,06 x rated voltage .....		254V		-
Three phase appliances 1,06 x rated voltage divided by $\sqrt{3}$ : .....				-
Leakage current between		I (mA)	Max. allowed I (mA)	
Live parts and output		0.2	0.25	
Live parts and enclosure wrapped with metal foil*		3.2	3.5	
* fixed appliance.				

16.3	TABLE: TABLE: Electric strength			P
Test voltage applied between: (all models)		Voltage (V)	Breakdown (Yes/No)	
Primary and earth		AC 1250	No	
Primary and output		AC 3000	No	
Primary and enclosure wrapped with metal foil		AC 3000	No	

17	TABLE: Overload protection, temperature rise			P
Temperature rise of part/at:		dT (K)	Max. dT (K)	
T1 winding (for overload test, after D101)		61 (ambient at 24°C)	175	
T1 winding (for overload test, after D101)		60 (ambient at 24°C)	175	
T1 winding (for overload test, after D200)		66 (ambient at 23°C)	175	
T1 winding (for overload test, after D200)		63 (ambient at 25°C)	175	
Notes:				

19.7	TABLE: Abnormal operation, locked rotor/moving parts					N
	Test voltage (V) .....	:				-
	Ambient, t <sub>1</sub> (°C) .....	:				-
	Ambient, t <sub>2</sub> (°C) .....	:				-
Temperature of winding		R <sub>1</sub> (&)	R <sub>2</sub> (&)	dT (K)	T (°C)	Max. T (°C)

19.9	TABLE: Abnormal operation, running overload					N
	Test voltage (V) .....	:				-
	Ambient, t <sub>1</sub> (°C) .....	:				-
	Ambient, t <sub>2</sub> (°C) .....	:				-
Temperature of winding		R <sub>1</sub> (&)	R <sub>2</sub> (&)	dT (K)	T (°C)	Max. T (°C)

19.13	TABLE: Abnormal operation, temperature rises		P
Thermocouple locations		dT (K)	Max. dT (K)
T1 winding (for Q3 B-E shorted test)		41 (ambient at 25°C)	175
T1 winding (for SCR A-G shorted test)		40 (ambient at 25°C)	175
T1 winding (for SCR, R-C shorted test)		41 (ambient at 25°C)	175
T1 winding (for Q1, G-D shorted test)		47 (ambient at 24°C)	175
T1 winding (for C301 shorted test)		47 (ambient at 25°C)	175
T1 winding (for R12 opened test)		45 (ambient at 23°C)	175
T1 winding (for C48 opened test)		44 (ambient at 27.0°C)	175

19.13	TABLE: Abnormal operation, winding temperature					P
	Test voltage (V) .....	:				-
	Ambient, t <sub>1</sub> (°C) .....	:				-
	Ambient, t <sub>2</sub> (°C) .....	:				-
Temperature of winding		R <sub>1</sub> (&)	R <sub>2</sub> (&)	dT (K)	T (°C)	Max. T (°C)
See table 19.13 above.						

24.1 TABLE: Components					P
Object / part No.	Manufacturer/ trademark	Type / model	Technical data	Standard	Mark(s) of conformity
Enclosure	Various	---	94V-1 or better	UL94	UL
Plug	Shangjing	LT-302	10A 250V	-	VDE
Power cord	TRIACE	H02VVH2-F	2X0.75mm <sup>2</sup>	IEC 60227	VDE, KEMA
Fuse (FS1)	Coquer	UBM	F2.5A, 250V	IEC/EN 60127-2	VDE
DC Fan (only)	CHENRI	KDE1204PKV2	12Vdc, 0.09A, 7.7 CFM	IEC/EN 60950	TUV, UL
Transformer (TX1)	Varoious	150622	Class b	iec 60335-2-29	Test with appliance
--Bobbin	SUMITOMO BAKELITE CO LTD	PM-9820	V-0, 150°C, Min. 0.51mm thickness	UL 94	Ul
--Insulation tape	JINGJIANG YAHUA PRESSURE SENSITIVE GLUE CO LTD	PZ	130°C	UL 510	ul
--Margin tape	JINGJIANG YAHUA PRESSURE SENSITIVE GLUE CO LTD	WF	130°C	UL 510	ul
-Tubing	ZEUS INDUSTRIAL PRODUCTS INC	TFE-TW-300	300V, 200°C	UL 224	ul
PCB	Various	-	V-0, 130°C, Min. thickness	UL94	ul

28.1 TABLE: Threaded part torque test				P
Threaded part identification	Diameter of thread (mm)	Column number (I, II, or III)	Applied torque ( Nm )	
Enclosure screw	2.9	II	0.5	
Earth screw	2.9	II	0.5	

29.1	TABLE: Clearances					P
	Overvoltage category.....:	II				-
		Type of insulation:				
Rated impulse voltage (V):	Min. cl (mm)	Basic	Functional	Supplementary	Reinforced	Verdict / Remark
330	0,5					N
500	0,5					N
800	0,5					N
1500	1,0					N
2500	2,0	X	X	--		
4000	3,5				X	p
6000	6,0					N
8000	8,5					N
10000	11,5					N



**ATTACHMENT: PHOTOS OF EUT**



Photo 1

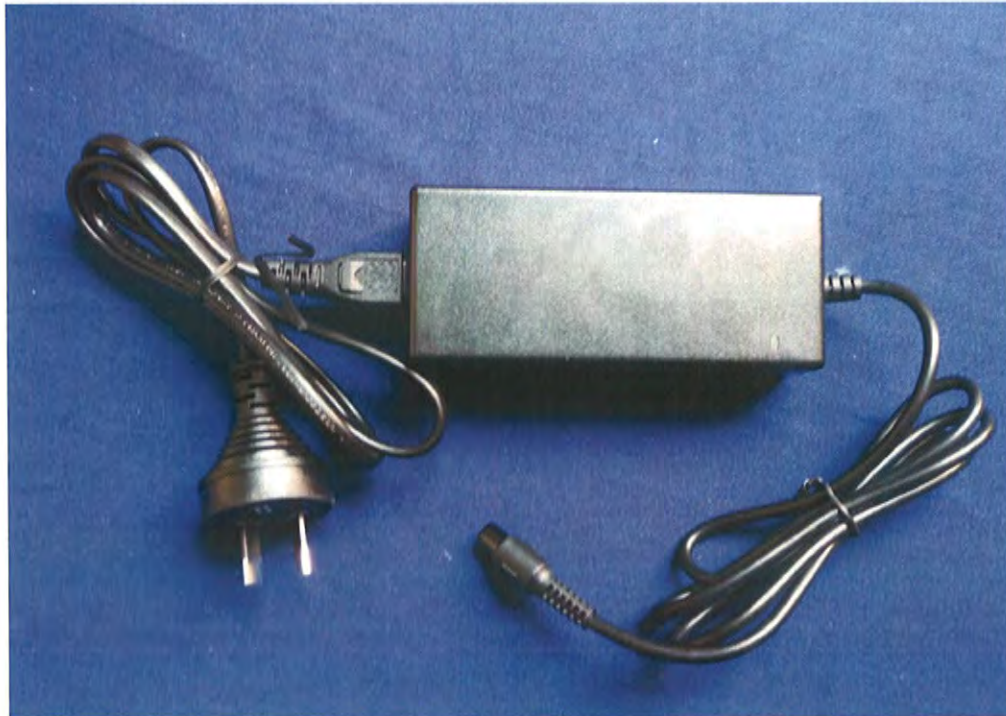

Photo 2

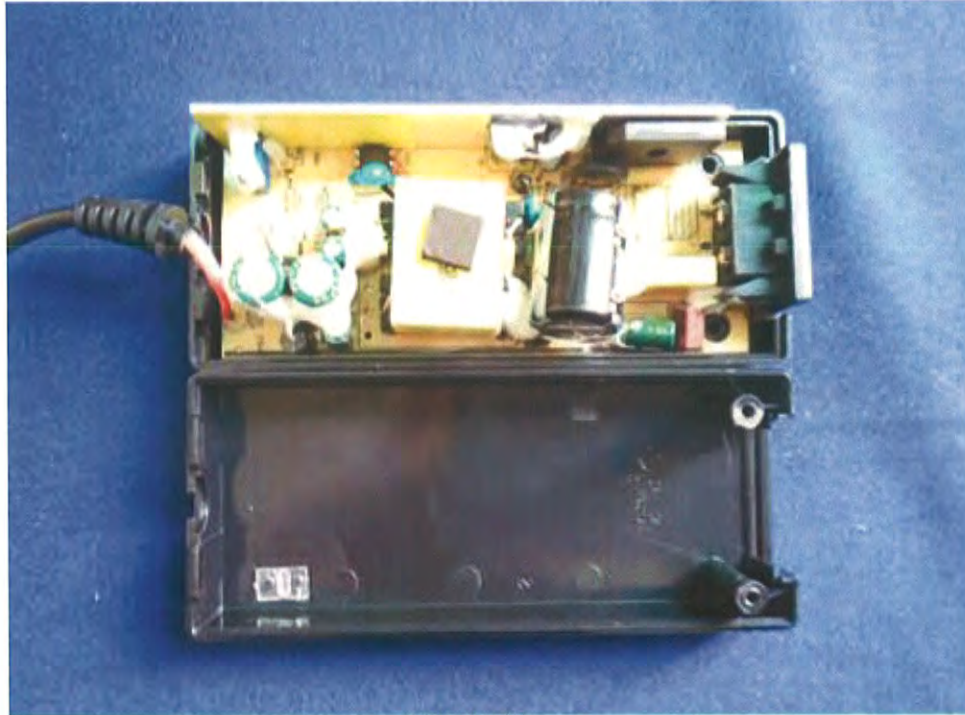

Photo 3

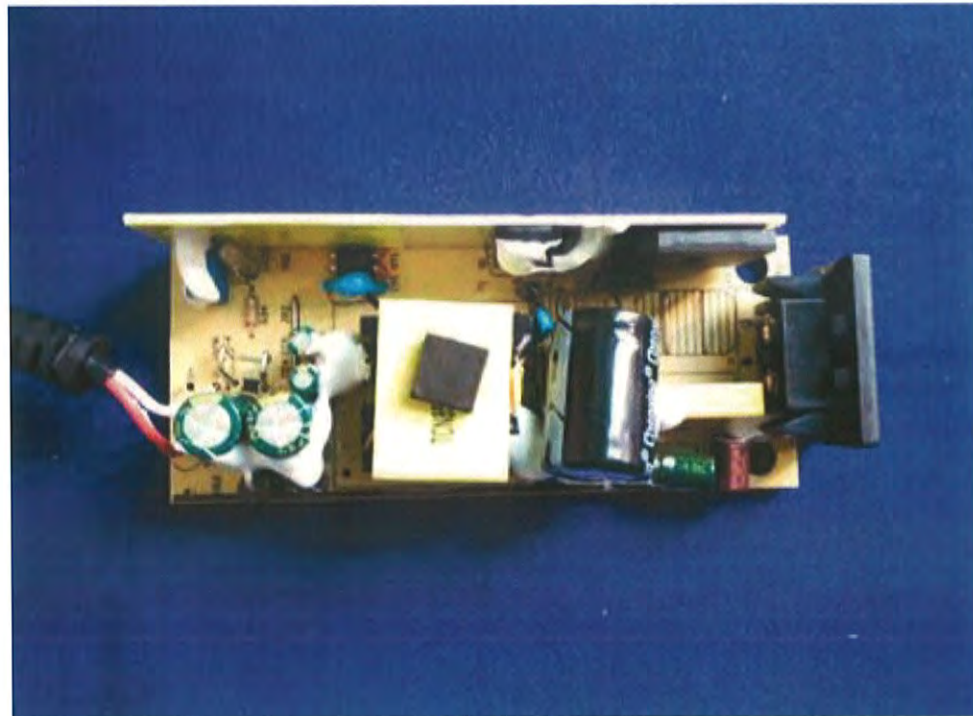

Photo 4

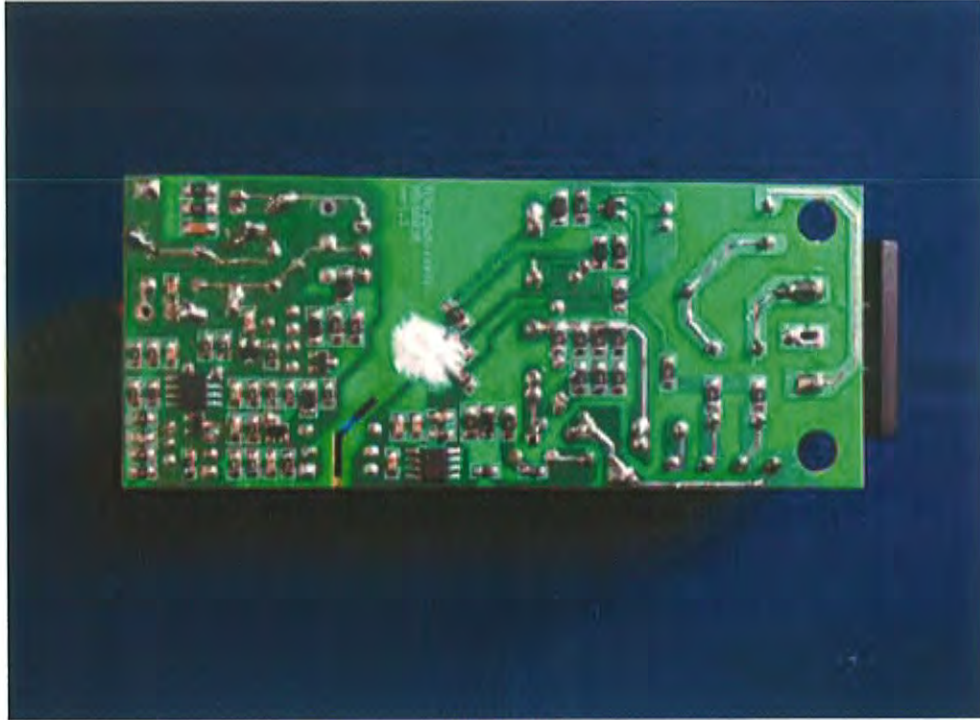

Photo 5

**\*\*\* The end of report \*\*\***